

TM 2005

Ampey 300 Series

MULTI-CHANNEL
EQUIPMENT

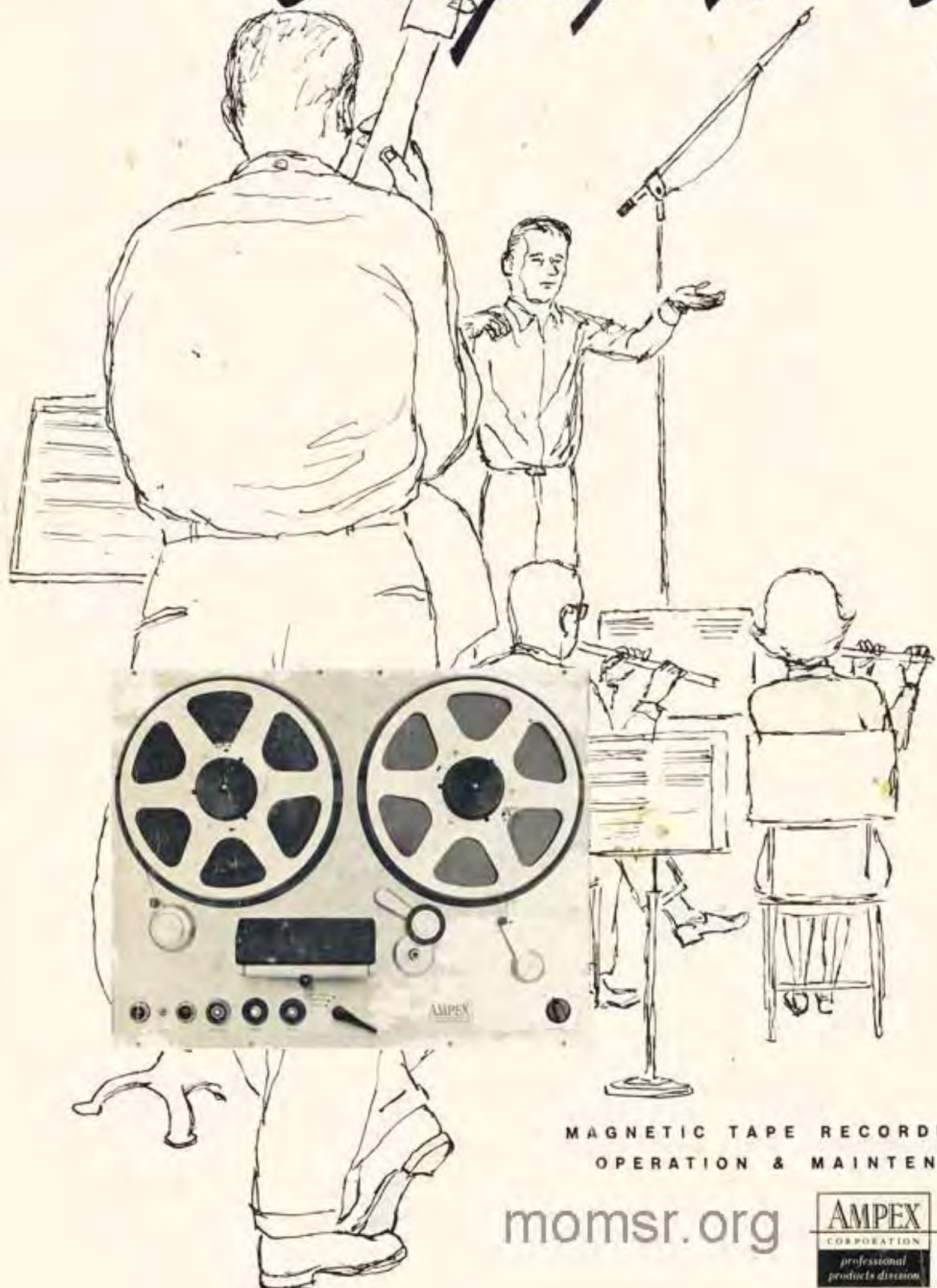

MAGNETIC TAPE RECORDER/REPRODUCER
OPERATION & MAINTENANCE MANUAL

momsr.org



Ampey 300 Series



MAGNETIC TAPE RECORDER/REPRODUCER
OPERATION & MAINTENANCE MANUAL

August 1959



AMPEX MODEL 300 RECORDER/REPRODUCER

T A B L E O F

CONTENTS

section	topic	page
1	DESCRIPTION AND PERFORMANCE CHARACTERISTICS	1-1
	GENERAL	1-1
	PERFORMANCE CHARACTERISTICS	1-2
	AMPEX MASTER EQUALIZATION	1-4
	AMPEX MULTICHANNEL SERIES 300-2-3 and 4 COMPLETE EQUIPMENT	1-4
2	INSTALLATION	2-1
	GENERAL	2-1
	INTERCONNECTING	2-2
	MOUNTING	2-2
	OUTPUT	2-2
	INPUT	2-2
	PHONES	2-4
	REMOTE CONTROL	2-4
	60 CYCLE AMPLIFIER	2-5
	OVERALL PERFORMANCE CHECK	2-5
	DISTORTION	2-5
	FLUTTER AND WOW	2-5
	INTERCONNECTING 300-3, 300-4	2-5
	INTERCONNECTING 300-2 and 300-2M	2-6
	INTERCONNECTING 300-3 1/2 INCH TAPE SEPARATE ERASE SEL-SYNC	2-8
	INTERCONNECTING 300-4 1/2 INCH TAPE SEPARATE ERASE SEL-SYNC	2-10
3	OPERATION	3-1
	GENERAL	3-1
	SUMMARY OF CONTROLS, SWITCHES AND INDICATORS	3-2
	OPERATING TECHNIQUES	3-5
4	THE DEVELOPMENT AND THEORY OF MAGNETIC TAPE RECORDING	4-1

T A B L E O F

CONTENTS

section	topic	page
5	TAPE TRANSPORT MECHANISM	5-1
	GENERAL	5-1
	TAPE SUPPLY AND TAKEUP SYSTEMS	5-1
	TAPE DRIVE SYSTEM	5-3
	BRAKE OPERATION	5-5
	CONTROL CIRCUIT	5-5
	ROUTINE MAINTENANCE	5-8
	ADJUSTMENTS	5-11
	SPRING SCALE READING	5-12
	REMOTE CONTROL	5-15
	PARTS LIST, TAPE TRANSPORT	5-16
	SCHEMATIC DIAGRAM, TAPE TRANSPORT CONTROL CIRCUITS (ONE FOLDOUT SHEET)	
6	THE AMPEX MAGNETIC HEAD	6-1
	INDIVIDUAL REPLACEABLE HEAD PARTS	6-4
7	ELECTRONIC ASSEMBLY	7-1
	GENERAL	7-1
	RECORD AMPLIFIER	7-2
	REPRODUCE AMPLIFIER	7-3
	BIAS AND ERASE OSCILLATOR	7-4
	POWER SUPPLY	7-5
	ALIGNMENT AND PERFORMANCE CHECKS	7-5
	MAINTENANCE AND TROUBLESHOOTING	7-10
	SEL-SYNC (SELECTIVE SYNCHRONISM)	7-15
	PARTS LIST (THREE AND FOUR TRACK UTILIZING SEL-SYNC)	7-16
	PARTS LIST (ELECTRONIC ASSEMBLY)	7-16
	APPLICABLE RESPONSE CURVES (TWO FOLDOUT SHEETS)	
	PARTS LOCATION (ETCHED BOARDS)(ONE FOLDOUT SHEET)	
	SCHEMATIC DIAGRAMS (FOUR FOLDOUT SHEETS)	

section	topic	page
1	AMPEX MODEL 300 RECORDER/REPRODUCER	
2	CENTER TAP GROUNDED BALANCED OUTPUT AND STRAPPING	
	FOR +4 DBM EQUAL TO OVU ON THE METER	2-2
	MICROPHONES WITH 50 OHMS OR LESS IMPEDANCE	2-3
	HIGH IMPEDANCE MICROPHONE INPUT	2-3
	TYPICAL RACK LAYOUT	2-3
	INTERCONNECTING 300-2 and 300-2M	2-7
	SEL-SYNC SWITCHING PANEL 3 CHANNEL (BACK)	2-8
	SEL-SYNC SWITCHING PANEL 3 CHANNEL (FRONT)	2-8
	INTERCONNECTING 300-3 1/2-INCH TAPE	
	SEPARATE ERASE SEL-SYNC	2-9
	INTERCONNECTING 300-4 1/2-INCH TAPE	
	SEPARATE ERASE SEL-SYNC	2-12
	SEL-SYNC SWITCHING PANEL 4 CHANNEL (BACK)	2-13
	SEL-SYNC SWITCHING PANEL 4 CHANNEL (FRONT)	2-13
	MODEL 300-3, THREE TRACK RECORDER/REPRODUCER WITH SEL-SYNC	2-14
3	TAPE THREADING PATH	3-4
4	VALDEMAR POULSEN	4-1
	MAGNETIZATION OF TAPE	4-2
	RECORD HEAD	4-2
	RECORDING MEDIUM MAGNETIZATION CURVE	4-2
	REPRODUCE HEAD CHARACTERISTICS	4-3
	ACHIEVING FLAT OVERALL RESPONSE	4-4

L I S T O F

I L L U S T R A T I O N S

section	topic	page
5	TAPE TENSIONING	5-2
	BOTTOM VIEW, TAPE TRANSPORT	5-4
	RESISTOR AND RELAY BRACKET	5-6
	POWER PANEL, TAPE TRANSPORT	5-7
	DEMAGNETIZING THE HEADS	5-10
	BRAKE ADJUSTMENT, LOW SIDE	5-12
	BRAKE ADJUSTMENT, HIGH SIDE	5-12
	CAPSTAN IDLER PRESSURE MEASUREMENT	5-13
	BRAKE BAND REPLACEMENT	5-14
	REMOTE CONTROL	5-15
	SIMPLIFIED CONTROL CIRCUIT SCHEMATIC MODEL 300 TAPE TRANSPORT	5-20
6	STANDARD MULTICHANNEL HEAD CONFIGURATION	6-2
	TRACK CONFIGURATION MODEL 300-2M	6-3
	THREE TRACK HEAD ASSEMBLY	6-3
	FOUR TRACK HEAD ASSEMBLY	6-3
	HEAD AZIMUTH ADJUSTMENT	6-4
7	LOCATION OF ELECTRONIC SUBASSEMBLIES	7-1
	AMPLIFIER CHASSIS, FRONT PANEL	7-2
	AMPLIFIER CHASSIS, REAR VIEW	7-2
	BLOCK DIAGRAM RECORD CIRCUIT	7-2
	BLOCK DIAGRAM REPRODUCE CIRCUIT	7-4
	SIGNAL-TO-NOISE RATIO COMPUTATIONS	7-9
	MICROPHONE RESPONSE SET-UP	7-10
	SYSTEM BLOCK DIAGRAM	7-11
	TROUBLESHOOTING THE REPRODUCE AMPLIFIER	7-11
	TROUBLESHOOTING THE RECORD AMPLIFIER	7-11
	SEL-SYNC OPERATION	7-13

DESCRIPTION AND PERFORMANCE CHARACTERISTICS

GENERAL

Ampex Series 300 Magnetic Tape Recorder Reproducers are high quality precision instruments designed for the professional user who requires the finest, most faithful recording and reproduction.

Recorder reproducer equipment in the 300 series consists of a tape transport, a head assembly, electronic assemblies, and accessory units such as the Sel-Sync panel.

The tape transport mechanism, capable of handling up to 10½-inch reels, is available for operation at tape speed pairs* of 3¾-7½ inches per second (ips) or 7½-15 ips, using ¼, ½ or 1-inch magnetic tape width, depending on the version of the equipment desired. By arrangement with Ampex Professional Products Contract Engineering, a tape transport mechanism handling 14 inch reels, may be obtained. Equalization switching is available for 3¾ ips NAB, 7½ ips NAB, 15 ips NAB and 15 ips Ampex Master Equalization (AME). (See AME discussion at the back of this section.) The accessory Sel-Sync panel provides a head switching arrangement which makes any selected record head perform the function of a reproduce head

so that any one, two, or more tracks can be monitored while recording on another track.

A variety of head assemblies are offered—two, three, and four track—with the configuration depending on the demands of the user. The Ampex Model 300-2M equipment, for instance, is designed for making special ½-inch wide master tapes on which two dual track stereophonic programs are recorded in opposite directions on the tape. The section in this manual dealing with head assemblies covers the subject thoroughly.

The electronic assemblies, featuring etched board construction, are mounted in a single chassis. Three etched boards contain the major portion of the electronic components: the record amplifier and the bias and erase oscillator are located on one board, the reproduce amplifier on a second board, and the power supply on the third board.

CCIR equalization for operation to European standards can be obtained when ordering equipment.

Console and rack mounting arrangements are available.

*30 ips can be achieved by means of a capstan adaptor, but equalization must be changed.

PERFORMANCE CHARACTERISTICS

<i>Tape Widths</i>	1/4, 1/2 and 1-inch
<i>Tape Speed Pairs</i>	3 3/4-7 1/2 ips 7 1/2-15 ips 30 ips (by arrangement with Ampex Professional Products Contract Engineering)

<i>Frequency Response</i>	Speed (ips)	Response (cycles per second)
	3 3/4	±2 db 50 to 7,500 cycles
	7 1/2	±2 db 40 to 10,000 cycles
		±4 db 30 to 15,000 cycles
	15 (NAB or AME)	±2 db 30 to 15,000 cycles
	30	±2 db 50 to 15,000 cycles

<i>Signal-to-Noise Ratio</i>	Speed (ips)	Peak Record Level to Unweighted Noise (db)
	3 3/4	50 db
	7 1/2	55 db
	15	55 db
	30	55 db

The peak record level is defined as that level at which the overall (input to output) total rms harmonic distortion does not exceed 3% when measured on a 400 cycle tone. Noise is measured when erasing a signal of peak recording level in the absence of new signal. Thus, bias and erase noise are included as well as playback amplifier noise. All frequencies between 50 and 15,000 cycles are measured.

<i>Flutter and Wow</i>	Speed (ips)	Flutter and Wow (percentage rms)
	3 3/4	.25
	7 1/2	.2
	15	.1
	30	.1

The flutter and wow measurements include all components between 0 to 300 cycles using an rms meter calibrated to read the rms value of constant amplitude sine wave flutter.

<i>Reproducing Time</i> (NAB 10 1/2-inch Diameter Reels, 2400 feet of tape)	Speed (ips)	Half Track		Full Track	
		(hrs)	(min)	(hrs)	(min)
	3 3/4	4	16	2	8
	7 1/2	2	8	1	4
	15	1	4		32
	30		32		16

Starting Time The tape is accelerated to full speed in less than 1/10 of a second (1/4 inch tape). Acceleration for 1/2-inch tape is approximately 1/2 of a second.

Stopping Time When operating at 15 ips, the tape moves less than two inches after the STOP button is pressed, at 7 1/2 ips less than one inch.

<i>Reproduce Timing Accuracy</i>	Accuracy (percentage)	Accuracy (sec)	Length of Recording (min)
	±.2	±3.6	30

Rewind Time Approximately 1 minute for a full 2,400 foot NAB reel.

PERFORMANCE CHARACTERISTICS (Contd.)

Controls

Tape Motion All tape motion is controlled by two pushbuttons and a mode selector switch.

The two pushbuttons control START and STOP functions, and the switch provides a means for selecting FAST FWD, REWIND and PLAY.

Record Control A separate RECORD button on the face of the electronic assembly, when pressed, energizes the record relay for that channel only. The relay drops out when the STOP button is pressed.

When the RECORD button on the tape transport is pressed all channels are placed in the record mode.

Equalization An EQUALIZATION SWITCH on the face of the electronic assembly provides a means for selecting 7.5 NAB, 15 NAB or 15 AME equalization.*

Record Inputs The INPUT TRANSFER SWITCH provides a means for selecting three different types of inputs:

Input	Input Impedance	Minimum Input Signal that will produce Operating Level (1% tape characteristic distortion)
MICROPHONE	150 to 250 ohms nominal (transformer can be strapped for 30-50 ohms nominal)	200 microvolts
BAL BRIDGE	200 K ohms	-10 dbm
UNBAL BRIDGE	100 K ohms	-10 dbm

Reproduce Output Zero indication on the v-u meter corresponds to +8 dbm -1 db. Sufficient gain and power handling capabilities exist to feed a +14 vu line output into 600 ohms balanced or unbalanced. The center tap of the output transformer can be strapped to ground for balanced output. Plus 4 vu also can be obtained by strapping. (See INSTALLATION.)

Head Housing The erase, record, and reproduce heads are contained in a single head housing.

Power Requirements Two track equipment requires approximately 3.5 amperes peak at 117 volts, 300 watts nominal, 50 and 60 cycles per second (cps).

In general, the addition of each amplifier increases the power requirement by .5 ampere and 50 watts.

*See AME discussion at back of this section.

AMPEX MASTER EQUALIZATION

Because hearing sensitivity has been determined to be more generally acute between 2,000 and 5,000 cycles, Ampex engineering designers have introduced greater pre-emphasis in the record circuitry and more de-emphasis in the reproduce circuitry in this frequency range. This results in a reduction of subjective noise—the noise heard rather than the noise measured on a VTVM—of about 7 db.

Appropriate curves used for AME operation are shown in back of SECTION 7.

AMPEX MULTICHANNEL SERIES 300-2-3 and 4 COMPLETE EQUIPMENT

<i>Model</i>	<i>Channel</i>	<i>Mounting</i>	<i>Inch Per Second (ips)</i>	<i>Track</i>	<i>Cycle</i>	<i>Tape Width</i>	<i>Ampex Cat. No.</i>
300-2	2 Full	Rack	7½-15	Two	60	¼ inch	30902-01
300-2	2 Track	Rack	7½-15	Track	50	¼ inch	30902-02
300-2	2 "	Console	7½-15	in-line	60	¼ inch	30902-03
300-2	2 "	Console	7½-15	Stereo only	50	¼ inch	30902-04
300-2 M	2 No	Rack	7½-15	(2 Track	60	½ inch	30902-05
300-2 M	2 Erase	Rack	7½-15	4 track	50	½ inch	30902-06
300-2 M	2 "	Console	7½-15	configur-	60	½ inch	30902-07
300-2 M	2 "	Console	7½-15	ation.)	50	½ inch	30902-08
300-3	3 (Indi-	Rack	7½-15	3 in-line	60	½ inch	30903-01
300-3	3 vidual	Rack	7½-15	3 in-line	50	½ inch	30903-02
300-3	3 erase)	Console	7½-15	3 in-line	60	½ inch	30903-03
300-3	3 "	Console	7½-15	3 in-line	50	½ inch	30903-04
300-3 SS (Sel Sync)	3 "	Rack	7½-15	3 in-line	60	½ inch	30903-05
300-3 SS	3 "	Rack	7½-15	3 in-line	50	½ inch	30903-06
300-3 SS	3 "	Console	7½-15	3 in-line	60	½ inch	30903-07
300-3 SS	3 "	Console	7½-15	3 in-line	50	½ inch	30903-08
300-4 SS (Sel Sync)	4 "	Rack	7½-15	4 in-line	60	½ inch	30904-01
300-4 SS	4 "	Rack	7½-15	4 in-line	50	½ inch	30904-02
300-4 SS	4 "	Console	7½-15	4 in-line	60	½ inch	30904-03
300-4 SS	4 "	Console	7½-15	4 in-line	50	½ inch	30904-04

INSTALLATION

GENERAL

Open the packing case carefully and save it. In the event of possible shipping damage the case may be needed for return shipment. Install the equipment in the rack so that the head cables will reach the electronic unit without being extended in length. Do not lengthen the head cables for any reason whatsoever, because increased cable capacity will adversely effect frequency response. Install all cables as indicated in the applicable interconnecting instructions.

Release the capstan drive motor shipping lock—a spring catch holding the motor away from the rubber-tired flywheel. Break the retaining ring and remove the lock from the motor bracket. Do not make any adjustments on the drive system at this time (none should be needed unless damage has occurred during shipping).

NOTE

Whenever the recorder is transported, be sure to relock the motor, or the capstan tire may be damaged beyond repair.

Connect the power cord to the appropriate a-c power source.

Check the capstan speed with the stick-on strobosticker provided. Before checking, let the drive unit run for at least five minutes to warm up the lubricant in the capstan assembly. If the lubricant is stiff, additional drag will cause greater compression of the rubber tire and the capstan will run slower until warmed up. Place the strobosticker on the capstan shaft with the sticky side down and view the rotating shaft under a 60 cycle light. If the speed is not correct the spokes will appear to rotate. Slight speed changes can be realized by a change in the capstan drive motor pressure. This adjustment is at spring D, on the motor solenoid draw bar (see the illustration BOTTOM VIEW, TAPE TRANSPORT). If the adjustment is in the proper range, increasing pressure will slow the capstan, decreasing pressure will speed the capstan. Adjust for no rotation of the strobosticker spokes. (If the drive motor pressure is too light, increasing pressure will speed the capstan. In this range the tire pressure is inadequate for stable operation, and the pressure should be increased until an increase in pressure reduces the capstan speed.)

Thread the tape as shown in the appropriate tape threading illustration, making certain that the oxide-coated side will contact the heads.

Remove any adhesive material used to seal the end of the reel of tape to avoid breakage at the finish of rewind. Run new reels of tape through in fast forward for inspection.

INTERCONNECTING

Refer to the appropriate interconnecting information at the back of this section.

MOUNTING

Console equipment is shipped in a ready-to-operate condition. It is necessary only to connect the power cable to a convenient a-c source.

Equipment intended for rack mounting is designed to fit a standard 19-inch wide rack (see the illustration, TYPICAL RACK LAYOUT).

NOTE

A different Drive Motor return spring is used for console, portable and rack mount machines. Information on this may be found in Section 5 (TAPE TRANSPORT MECHANISM).

OUTPUT

A mating connector for LINE OUTPUT is supplied. The user must fabricate his own cables.

Studio Line

Plus 8 vu, 600 ohm line output, balanced or unbalanced, is available across terminals 2 and 3 of the LINE OUT connector, J-5. Pin 1 is the chassis ground.

If unbalanced output is desired, wire the mating connector so that the pin 2 side of the line is tied to ground or tie A to B at TS1. Supply 600 ohm termination to this output at all times to maintain correct meter calibration while recording or reproducing. If the output is not feeding a terminated line, or if the output is not connected, such as on remote pickups, the line out termination switch, S4, must be left in the ON position.

To obtain a center tap grounded, balanced output, strap the black lead of transformer T3

to ground at the tie point shown in the illustration — CENTER TAP GROUNDED BALANCED OUTPUT AND STRAPPING FOR 4 VU OUTPUT.

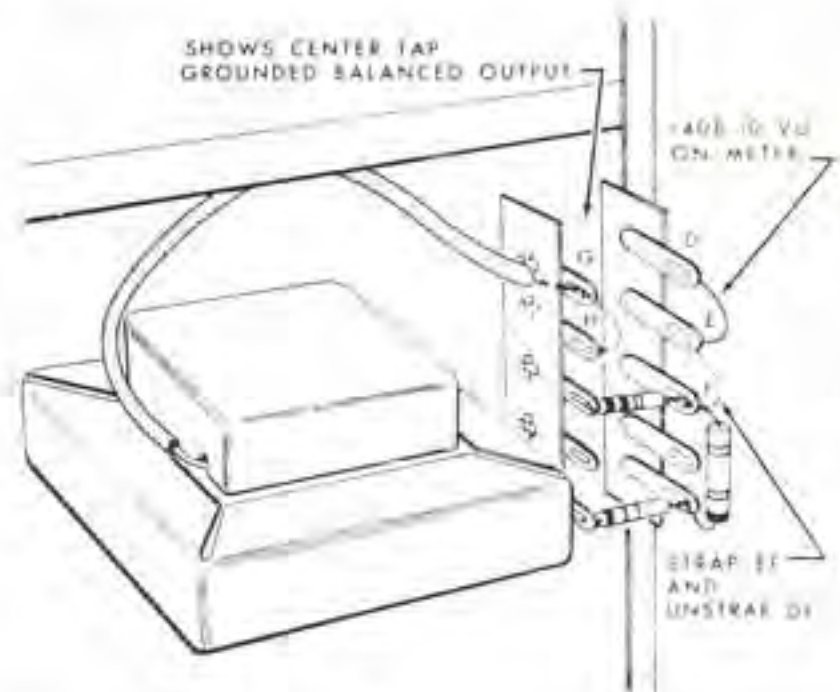

CENTER TAP GROUNDED BALANCED OUTPUT AND STRAPPING FOR +4 DBM EQUAL TO 0 VU ON THE METER

Plus 4 vu output can be achieved by unstrapping D and E at transformer T3 and strapping E to F. Readjust the record calibration according to the instructions in SECTION 7 ALIGNMENT AND PERFORMANCE CHECKS.

High Impedance Amplifier Output

Wire the mating connector so that pin 3 of the line out connector, J5 is connected to the high side of the amplifier input. Strap pins 1 and 2 of the mating connector for connection to the ground side of the amplifier input. The line out termination switch S4, must be left in the ON position at all times.

INPUT

Microphone Input

Any low impedance microphone having a nominal impedance between 30 and 250 ohms can be plugged directly into the equipment. Wire the mating connector so that the microphone is connected to pins 2 and 3 of LINE INPUT, J1. The cable shield must be connected to pin 1. Place the input transfer switch, S1, in the MIC position.

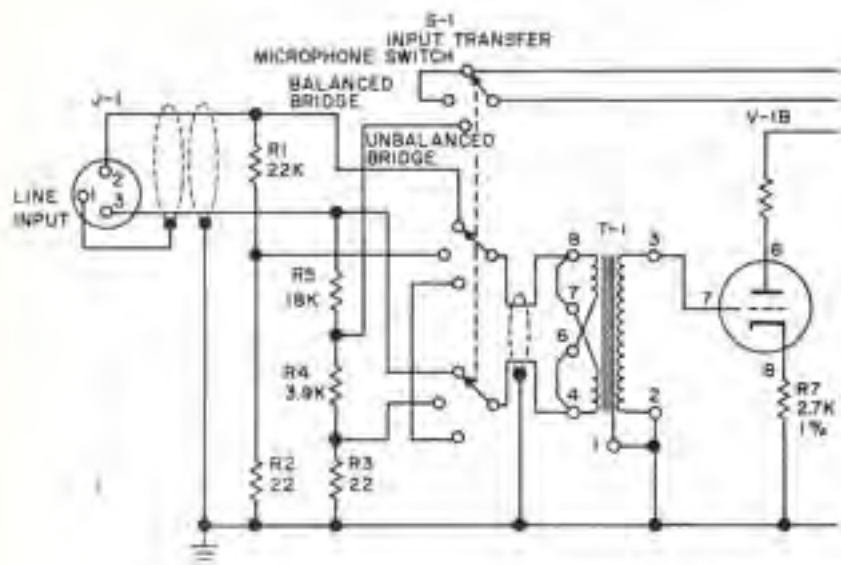

MICROPHONES WITH 50 OHMS OR LESS IMPEDANCE

The microphone input transformer is strapped for the optimum step up when using a 150 to 250 ohm source. With microphones of 50 ohms or less impedance, to obtain 6 db additional gain strap the input as shown in the illustration — MICROPHONES WITH 50 OHMS OR LESS IMPEDANCE. This should be done only if insufficient gain is found to exist when the input is fed from a source impedance less than 50 ohms.

IMPORTANT

To maintain flat response in the balanced bridge condition when the transformer is strapped for 50 ohms, change resistor values as follows:

- | | |
|-------------|--------------|
| R1—22K ohms | R3—22 ohms |
| R2—22 ohms | R4—3.9K ohms |
| R5—18K ohms | |

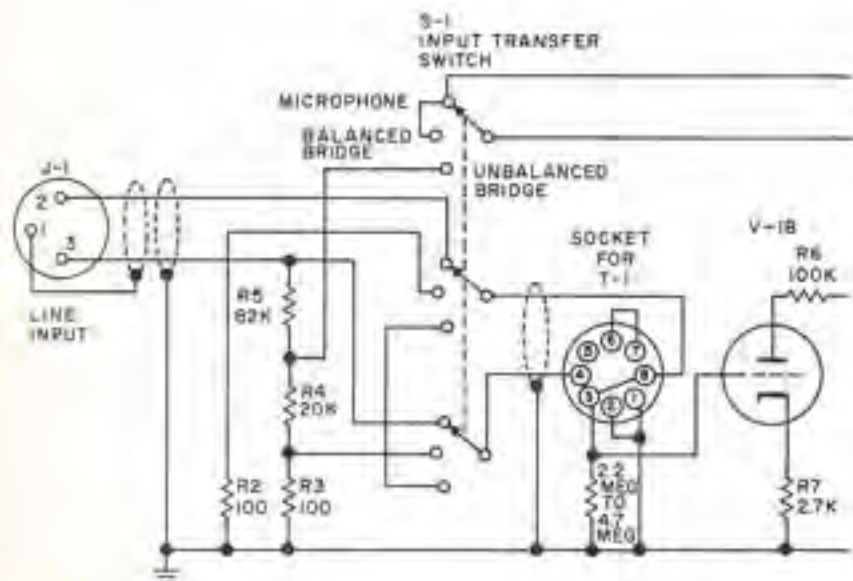

HIGH IMPEDANCE MICROPHONE INPUT

High impedance microphones are not recommended for use in this equipment because, in general, the quality is not satisfactory for professional work. If it becomes necessary to connect a high impedance microphone, the input circuit must be re-wired as shown in the illustration—HIGH IMPEDANCE MICROPHONE INPUT.

- Step 1: Remove the input transformer T1.
- Step 2: Remove the 100,000 ohm resistor R1 from the switch S1.
- Step 3: Between pin 3 and pin 1 on the input transformer socket, connect a resistance the value of which is between 2.2 megs and 4.7 megs.



TYPICAL RACK LAYOUT

- Step 4: Using a jumper, connect pin 3 to pin 8 on the transformer socket.
- Step 5: Wire the microphone input connector for connection to pins 1 and 2 (shield to pin 1), and leave pin 3 open.

Bridging a Balanced Studio Line

Connect a balanced line to pins 2 and 3 of the input connector, J1. Pin 1 is ground. Place the input transfer switch, (S401) in the BALANCED BRIDGE position. Input levels of -10 to +20 v-u can be accommodated. The load placed on the line is approximately 200,000 ohms.

Bridging on Unbalanced Source

Connect an unbalanced line, radio tuner, etc. to pins 1 and 3 of the input connector. Pin 1 is the ground side. Place the input transfer switch S1, in the UNBALANCED BRIDGE position. This connection provides a 100,000 ohm bridging input for any rms program voltage greater than .2 volt.

Gain Changes in Balanced Bridge or Unbalanced Bridge

An increase of 10 db in balanced and unbalanced bridge can be achieved by changing two resistors. Change R1 to 33,000 ohms and

R5 to 12,000 ohms. The resulting input impedances will be 66,000 ohms in the balanced bridge position and 30,000 ohms in the unbalanced bridge position.

An increase of 14 db unbalanced bridge gain without balanced bridge gain can be obtained by shorting out resistor R5 and changing R4 to 100,000 ohms. Resulting input impedance will be 50,000 ohms.

For a 10 db increase in balanced bridge gain without changing unbalanced bridge gain, change resistor R1 to 33,000 ohms, R5 to 27,000 ohms and R4 to 5,600 ohms. Resulting input impedances will be 66,000 ohms for balanced bridge and 33,000 ohms for unbalanced bridge.

SUMMARY

For Gain Increase	Component	New Value	New Input Impedance	
			BAL BRIDGE	UNBAL BRIDGE
10 db BAL BRIDGE and UNBAL BRIDGE	R1	33,000 ohms	66,000 ohms	30,000 ohms
	R5	12,000 ohms		
14 db UNBAL BRIDGE	R5	zero (short out)	200,000 ohms	50,000 ohms
	R4	100,000 ohms		
10 db BAL BRIDGE	R1	33,000 ohms	66,000 ohms	33,000 ohms
	R5	27,000 ohms		
	R4	5,600 ohms		

PHONES

High impedance head phones must be used. To monitor the incoming line or reproduce output, plug the high impedance phones into phone jack J6 PHONES on the amplifier face panel or J4 MONITOR on the back of the amplifier chassis. The monitor jack J4 is a high impedance unbalanced output isolated from

the main line. To preserve low frequency response, feed into an input impedance 50K or higher. To preserve high frequency response the cable should have not over 500 uuf of capacitance.

REMOTE CONTROL

Refer to the illustration—REMOTE CONTROL CIRCUIT (back of Section 5).

60 CYCLE AMPLIFIER:

(For precision drive motor power)

The Ampex Model 375 Precision 60 cycle amplifier can be plugged in directly at J805S. No other connections are necessary. If this unit is used with the recorder, the control circuits fuse must be increased by 5 amperes. Do not remove the dummy plug unless this unit is to be connected.

OVERALL PERFORMANCE CHECK

(Read SECTION 3, OPERATION before making these checks.)

Make the following equipment performance checks at the time of installation and when necessary thereafter:

REPRODUCE (Playback) LEVEL
REPRODUCE (Playback) RESPONSE
RESPONSE (Playback) NOISE
MEASUREMENT
RECORD CALIBRATION
FREQUENCY RESPONSE
RECORD NOISE MEASUREMENT

NOTE

It should be noted that this machine has been adjusted at the factory to produce frequency response within specifications when recording on an average tape. In the last few years the high frequency output from tape has improved tremendously. In order to keep pace with these improvements, in the summer of 1959 Ampex selected a new "average" tape to adjust bias and record equalization. Machines adjusted to the new average tape may be identified by the catalog number of the electronics, #30960 representing the revised machine.

It is important to realign the equipment for each type of tape used.

Complete instructions for making the above checks are given in SECTION 7 ALIGNMENT AND PERFORMANCE CHECKS.

DISTORTION

Overall distortion can be measured by connecting any standard distortion measurement

apparatus across the output. The readings from a wave analyzer or selective frequency distortion meter will be more accurate than those from a null type instrument at lower distortion levels. Distortion readings are somewhat dependent on tape. A reading of 1% is normal at operating level while a reading of 3% is normal at 6 db above operating level. Second harmonic distortion is negligible; measured distortion is predominantly third order.

FLUTTER AND WOW

Flutter and wow are produced by periodic irregularities in tape speed and appear as cyclic frequency deviations in recording or reproducing. They can be measured by means of any standard flutter bridge. Variations in amplitude as indicated on level measurements do not constitute flutter and are entirely due to tape coating variations. Readings will be near or below .1% rms at 30 inches, .1% rms at 15 inches, .2% rms at 7½ inch, and .25 rms at 3¾ inch speed. The Ampex Professional Products Division Primary Standard of Measurements is based on the use of a flutter meter calibrated to indicate the deviation from mean carrier frequency of any rate between 0 and 300 cycles per second (cps) expressed in percent rms.

INTERCONNECTING

300-3, 300-4

The Models 300-3, 300-4 and all other multi-track equipment, not including the Sel-Sync units, are interconnected as illustrated except that the cable quantities are increased, the bias coupling from the second electronic assembly to the third, fourth and following electronic assemblies requires an adaptor Tee, catalog number 169-012, and a bias coupling cable, catalog number 14943-02, and different power interconnecting cables, the number of segments depending on the number of electronic assemblies. The Model 300-3, for instance, has three each reproduce, record and erase head cables, uses the bias adaptor TEE 169-012 and 2 bias coupling cables 14943-02 and power interconnecting cable 30851-01.

For those models in the 300 Series which are equipped with Sel-Sync, refer to the appropriate interconnecting information.

INTERCONNECTING

300-2 and 300-2M

<i>Cable</i>	<i>Catalog Number</i>	<i>Qty.</i>	<i>Receptacle</i>	<i>From Chassis</i>	<i>Receptacle</i>	<i>To Chassis</i>
Reproduce Head	—————	(2)	Captive	Tape Transport	PLAYBACK HEAD, J3	Electronic Assemblies No. 1 and No. 2
Record Head	—————	(2)	Captive	Tape Transport	RECORD HEAD, J2	Electronic Assemblies No. 1 and No. 2
Erase Head	—————	(2)	Captive	Tape Transport J7	TAPE TRANSPORT, J7	Electronic Assemblies No. 1 and No. 2
Power Interconnecting	30841-01	(1)	POWER CABLE TO ELECTRONICS	Tape Transport	TAPE TRANSPORT, J7	Electronic Assemblies No. 1 and No. 2
A-c Power	—————	(1)	117V LINE	Tape Transport		Convenient a-c Outlet
Bias Coupling	14943-02	(1)	BIAS COUPLING, J9	Electronic Assembly No. 1	BIAS COUPLING, J9	Electronic Assembly No. 2

*The Model 300-2M has no erase head. Disregard the erase head connection.

Note: Cables marked with a red band interconnect in upper electronics for 300-2 and 300-2M tape transports only. Cables marked TRACK 1, 2, 3 and 4 indicate interconnection of electronics from top to bottom of the 300-3 or 300-4 tape transport.

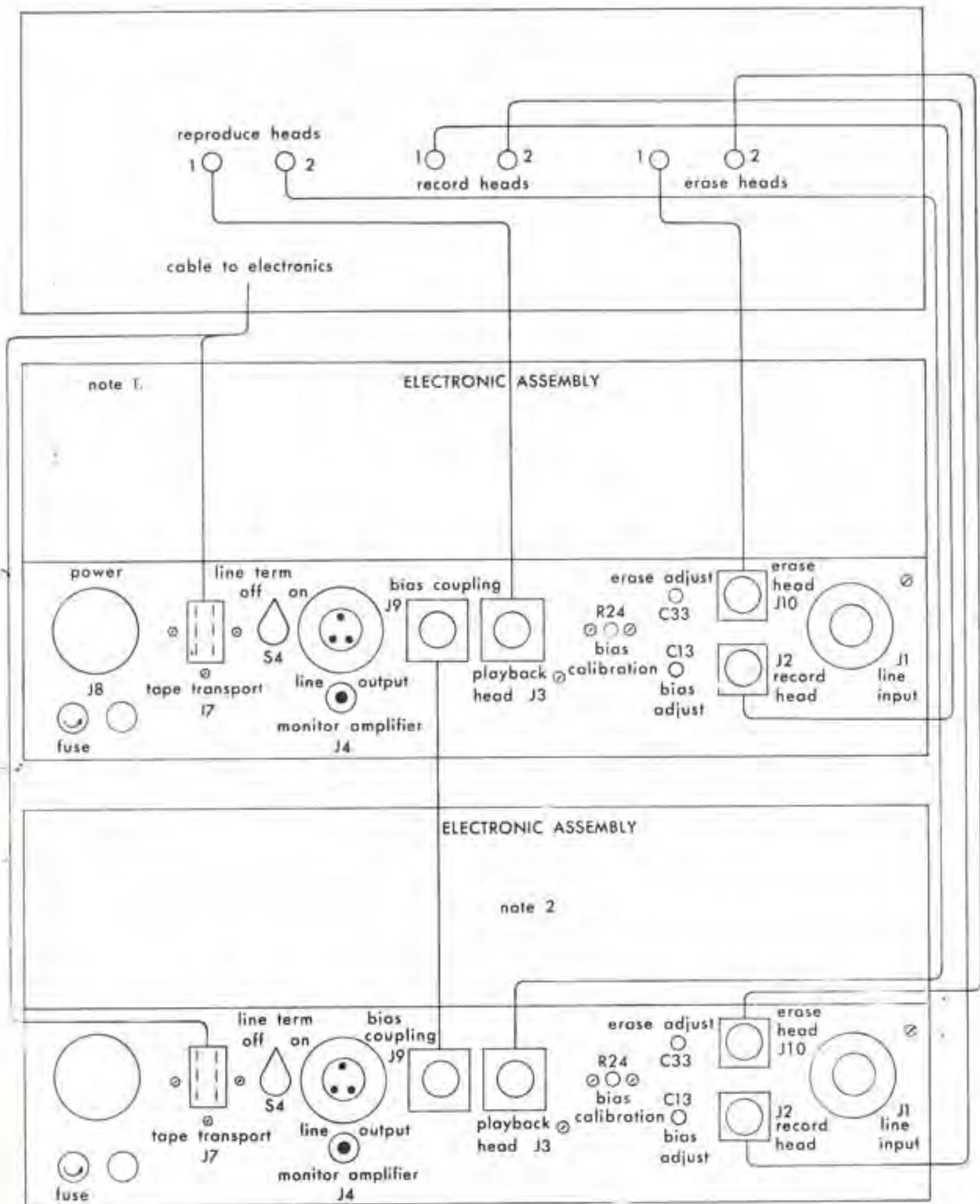

NOTES:

1. A 30841-01 power interconnecting "y" cable is used with dual track stereophonic and portable equipment.
2. A 14943-02 bias interconnecting cable is used with dual track stereophonic equipment.
3. Cables marked with a red band interconnect in upper electronics for 300-2 and 300-2M tape transports only. Cables marked track 1, 2, 3 and 4 indicate interconnection of electronics from top to bottom of the 300-3 or 300-4 tape transport.

**INTERCONNECTING
300-2 AND 300-2M**



SEL-SYNC SWITCHING PANEL
3 CHANNEL (BACK)



SEL-SYNC SWITCHING PANEL
3 CHANNEL (FRONT)

INTERCONNECTING

300-3 1/2-inch Tape
Separate Erase
Sel-Sync

<i>Cable</i>	<i>Catalog Number</i>	<i>Qty.</i>	<i>Connector</i>	<i>From Chassis</i>	<i>Connector</i>	<i>To Chassis</i>
A-C	084-005	(1)	117V LINE	Tape Transport Power Panel	A-C Source	Tape Transport
Power Extension	30852-01	(1)	POWER CABLE TO ELECTRONICS	Tape Transport Power Panel	TAPE TRANSPORT	Sel-Sync
Bias Interconnecting	*14943-02	(2)	BIAS COUPLING, J9	Electronic Assembly	BIAS COUPLING, J9	Next Electronic Assembly
Power Interconnecting	30853-01, 02 and 03	(3)	ELECTRONIC 1, 2 and 3	Sel-Sync	TAPE TRANSPORT J7	Electronic Assembly 1, 2 and 3
Playback Head	—————	(3)	Captive at Tape Transport		PB HEAD 1, 2 and 3	Sel-Sync
Record Head	—————	(3)	Captive at Tape Transport		RECORD HEAD 1, 2 and 3	Sel-Sync
Erase Head	—————	(3)	Captive at Tape Transport		ERASE HEAD J10	Electronic Assembly 1, 2 and 3
Playback Head Interconnecting	*30745-01, 02 and 03	(3)	PLAYBACK ELECT. 1, 2 and 3	Sel-Sync	PLAYBACK HEAD, J3	Electronic Assembly 1, 2 and 3
Record Head Interconnecting	*30008-12, 13 and 14	(3)	RECORD ELECT. 1, 2 and 3	Sel-Sync	RECORD HEAD J2	Electronic Assembly 1, 2 and 3

*Dash numbers indicate length.

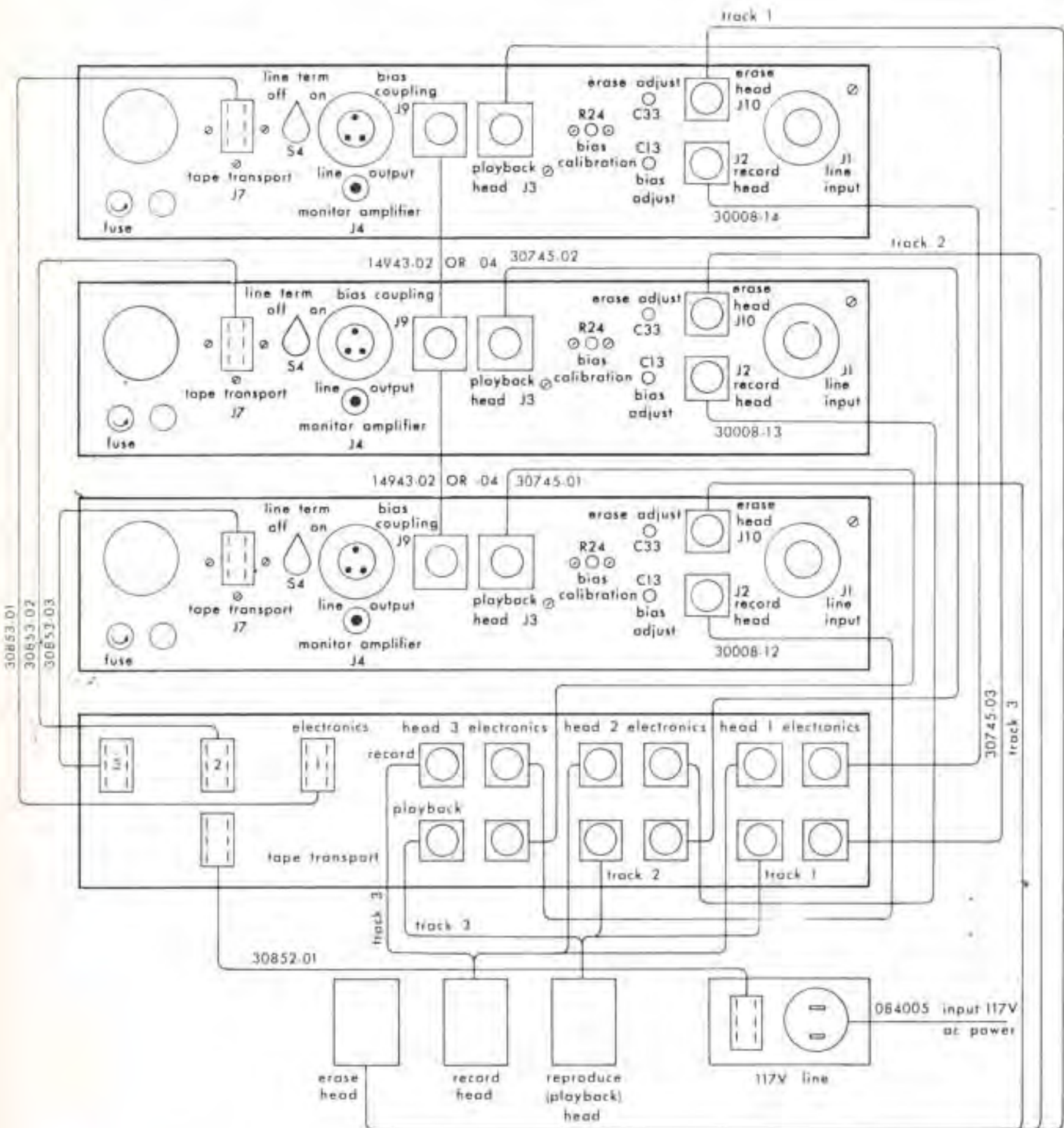

NOTES:

- 1) Cables marked Track 1, 2 and 3 indicate interconnection of the electronics from top to bottom, in conjunction with Erase, Record and Reproduce (Playback) Heads. All others are marked with part numbers and dash 1, 2 and 3 (designating length).

INTERCONNECTING 300-3
 1/2-INCH TAPE SEPARATE ERASE
 SEL-SYNC

INTERCONNECTING

300-4 1/2-inch Tape

Separate Erase

Sel-Sync

<i>Cable</i>	<i>Catalog Number</i>	<i>Qty.</i>	<i>Connector</i>	<i>From Chassis</i>	<i>Connector</i>	<i>To Chassis</i>
A-C	084-005	(1)	117V LINE	Tape Transport Power Panel	A-C Source	Tape Transport
Power Extension	*30852-01	(1)	POWER CABLE TO ELECTRONICS	Tape Transport Power Panel	TAPE TRANSPORT	Sel-Sync
Bias Interconnecting	*14943-02	(2)	BIAS COUPLING, J9	Electronic Assembly	BIAS COUPLING, J9	Between Electronic Assembly 1 and 2, 2 and 3
Bias Interconnecting	*14943-03	(1)	BIAS COUPLING, J9	Electronic Assembly	BIAS COUPLING, J9	Between Electronic Assembly 3 and 4
Power Interconnecting	*30853-08	(1)	ELECTRONICS NO. 1	Sel-Sync	TAPE TRANSPORT, J7	Electronic Assembly No. 1
Power Interconnecting	*30853-07	(1)	ELECTRONICS NO. 2	Sel-Sync	TAPE TRANSPORT, J7	Electronic Assembly No. 2
Power Interconnecting	*30853-06	(1)	ELECTRONICS NO. 3	Sel-Sync	TAPE TRANSPORT, J7	Electronic Assembly No. 3
Power Interconnecting	*30853-05	(1)	ELECTRONICS NO. 4	Sel-Sync		Electronic Assembly No. 4
Playback Head	TRACK 1, 2, 3 and 4	(4)		Captive at Tape Transport	PB HEAD TRACK 1, 2, 3 and 4	Sel-Sync
Record Head	TRACK 1, 2, 3 and 4	(4)		Captive at Tape Transport	RECORD HEAD TRACK 1, 2, 3 and 4	Sel-Sync
Erase Head	TRACK 1, 2, 3 and 4	(4)		Captive at Tape Transport	30825-06(07-08-09)	
Extension (Erase)	*30825-09	(1)		Connected to Erase Cable Track 1	ERASE HEAD J10	Electronic Assembly No. 1
Extension (Erase)	*30825-08	(1)		Connected to Erase Cable Track 2	ERASE HEAD, J10	Electronic Assembly No. 2
Extension (Erase)	*30825-07	(1)		Connected to Erase Cable Track 3	ERASE HEAD J10	Electronic Assembly No. 3
Extension (Erase)	*30825-06	(1)		Connected to Erase Cable Track 4	ERASE HEAD J10	Electronic Assembly No. 4
Playback Head Interconnecting	*31069-05	(1)	Playback Electronics, No. 1	Sel-Sync	PLAYBACK HEAD, J3	Electronic Assembly No. 1
Playback Head Interconnecting	*31069-04	(1)	Playback Electronics, No. 2	Sel-Sync	PLAYBACK HEAD, J3	Electronic Assembly No. 2
Playback Head Interconnecting	*31069-03	(1)	Playback Electronics, No. 3	Sel-Sync	PLAYBACK HEAD, J3	Electronic Assembly No. 3
Playback Head Interconnecting	*31069-02	(1)	Playback Electronics, No. 4	Sel-Sync	PLAYBACK HEAD, J3	Electronic Assembly No. 4
Record Head Interconnecting	*31070-05	(1)	Record Electronics, No. 1	Sel-Sync	RECORD HEAD J2	Electronic Assembly No. 1

Dash numbers indicate length.

INTERCONNECTING (Contd.)

300-4 1/2-inch Tape

Separate Erase

Sel-Sync

<i>Cable</i>	<i>Catalog Number</i>	<i>Qty.</i>	<i>Connector</i>	<i>From Chassis</i>	<i>Connector</i>	<i>To Chassis</i>
Record Head Interconnecting	*31070-04	(1)	Record Electronics, No. 2	Sel-Sync	RECORD HEAD J2	Electronic Assembly No. 2
Record Head Interconnecting	*31070-03	(1)	Record Electronics, No. 3	Sel-Sync	RECORD HEAD J2	Electronic Assembly No. 3
Record Head Interconnecting	*31070-01	(1)	Record Electronics, No. 4	Sel-Sync	RECORD HEAD J2	Electronic Assembly No. 4

*Dash numbers indicate length.

When ordering replacement parts always include the following information: Equipment Type; Equipment Serial Number; Ampex Part or Catalog Number; and Description of Part. DO NOT simply use the schematic reference number.

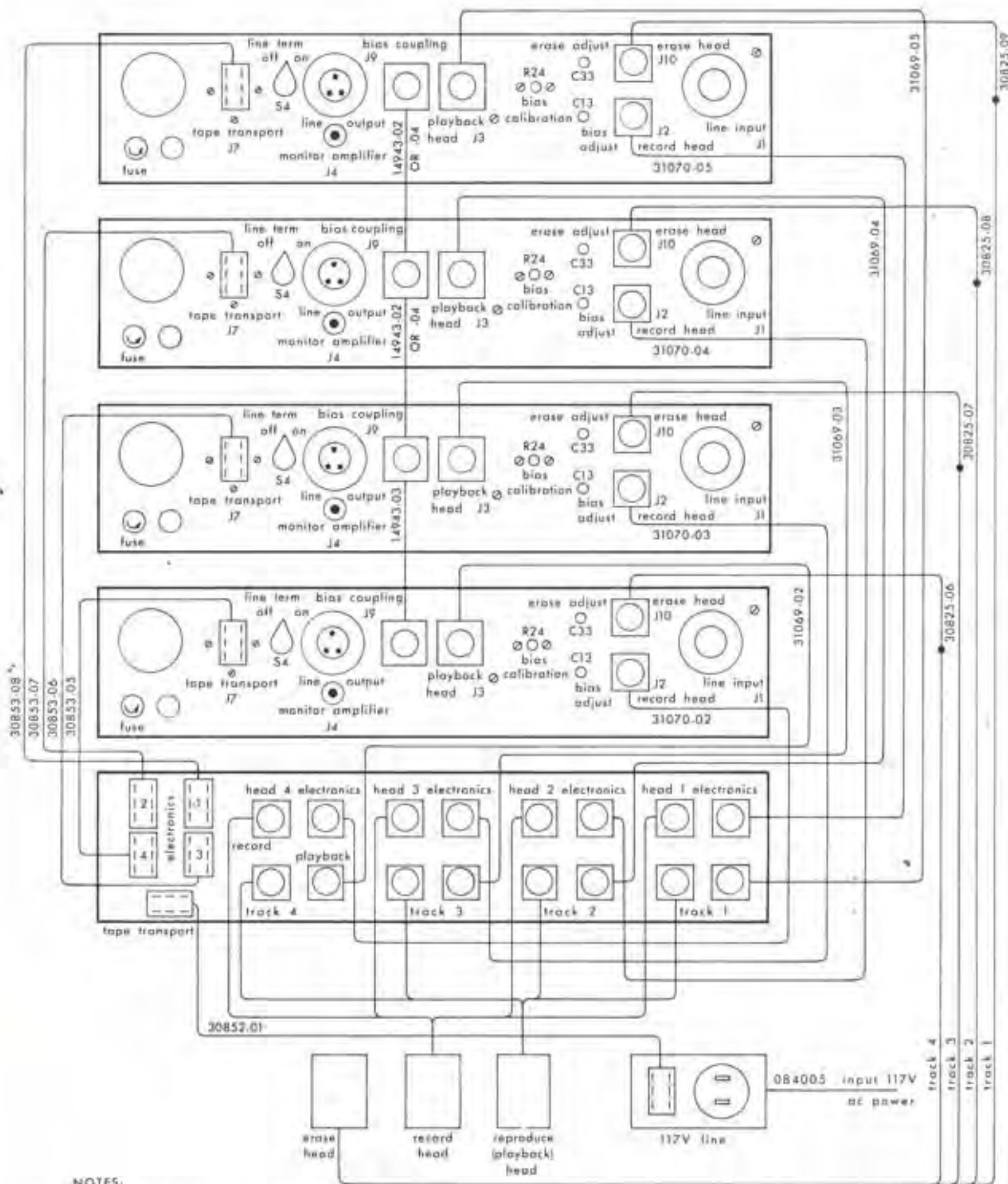

NOTES:

1. Cables marked track 1, 2, 3 and 4 indicate interconnection of the electronics from top to bottom, in conjunction with erase, record and reproduce (playback) heads. All others are marked with part numbers and dash 1, 2, 3 and 4 etc. (designating length).
2. Bias cables are used with an adaptor tee, catalog no. 169-012 coupling the electronics.

**INTERCONNECTING 300.4
1/2-INCH TAPE SEPARATE ERASE
SEL-SYNC**

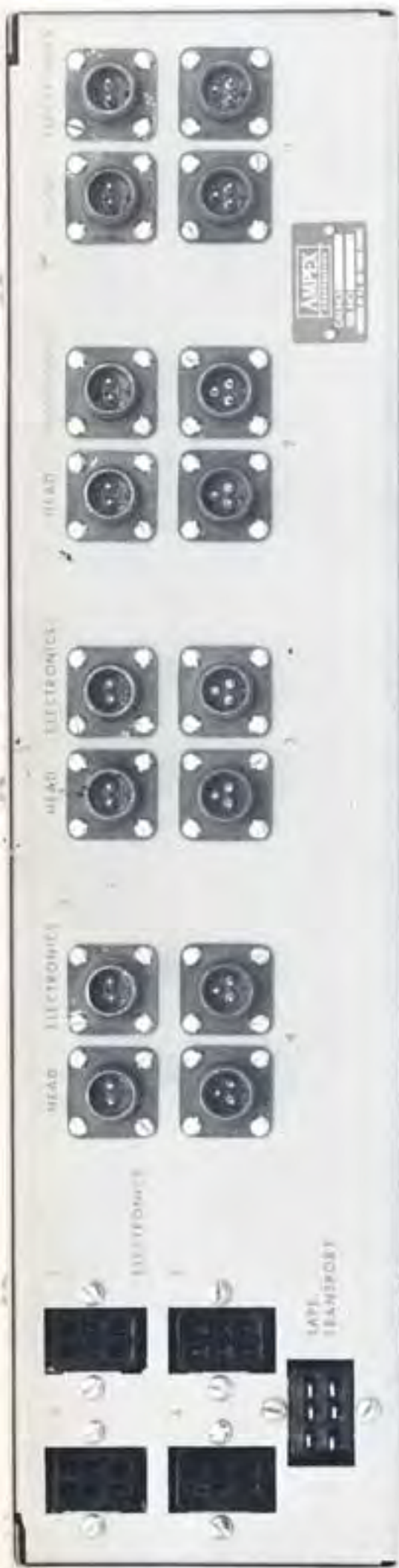

SEL-SYNC SWITCHING PANEL 4 CHANNEL (BACK)



SEL-SYNC SWITCHING PANEL 4 CHANNEL (FRONT)



MODEL 300-3, THREE TRACK
RECORDER/REPRODUCER WITH SEL-SYNC

3

SECTION

OPERATION

GENERAL

Series 300 recorder-reproducers are intended for multi-track operation. Tape motion is controlled by two pushbuttons START and STOP, and a mode selector switch for selecting PLAY, REWIND and FAST FWD functions. A RECORD pushbutton on the tape transport provides a means to select the record functions of all amplifiers simultaneously (concurrent recording). Record buttons are also located on each amplifier, providing a means for recording on any individual track or combination of tracks in the system. The equipment will accommodate the NAB 10½-inch diameter tape reels. The 14-inch diameter reel equipment is obtainable by arrangement with Ampex Professional Products Contract Engineering.

Either of two capstan drive motor speeds can be selected at the LOW-HIGH TAPE SPEED switch which is also on the tape transport.

On the front panel of the electronic assem-

bly are controls for setting RECORD LEVEL and (reproduce) PLAYBACK LEVEL, selecting 7½ ips NAB or 15 ips ABE EQUALIZATION, selecting three input arrangements by means of the INPUT TRANSPORT SWITCH, and switching the vu meter at the METER and OUTPUT switch so that (reproduce) PLAYBACK, RECORD, BIAS and ERASE LEVEL(s) can be read. A phone jack (PHONES) for monitoring, a RECORD button, a RECORD INDICATOR light, and a POWER OFF-ON switch are also mounted on the electronic assembly front panel.

Another MONITOR AMPLIFIER phone jack and a line termination (LINE TERM) OFF-ON switch are located on the back of the amplifier-chassis.

In operating your Tape Transport, the same size reel hubs should be used on both the supply and takeup sides, or the braking action might spill tape as one side brakes faster than the other (if different size reel hubs are employed).

SUMMARY OF CONTROLS, SWITCHES AND INDICATORS

<i>Item</i>	<i>Schematic Reference Symbol</i>	<i>Location</i>	<i>Function</i>
POWER switch	S801	Tape Transport	Controls all power to the entire system. When this switch is on, capstan rotates* (if tape is properly threaded) and all electronic assembly vu meters will light provided the individual amplifier power switches are on.
POWER INDICATOR	A801	Tape Transport Control Cluster	Lights when main power switch is on.
POWER OFF-ON SWITCH	S-5	Electronic Assembly front panel	Controls power to the electronic assembly. The v-u meter lamps light when main power is on, and are unaffected by the safety switch, remaining lighted till the power is turned off, either at this switch or the main power switch on the tape transport.
TAPE SPEED	S502 and S503	Tape Transport Control Cluster	Determines speed of the capstan drive motor by high or low speed winding. Used in conjunction with EQUALIZATION switch S2.
EQUALIZATION 7½ NAB 15 NAB 15 AME	S2	Electronic Assembly front panel	Used to select appropriate equalization circuitry for tape speed chosen.
METER AND OUTPUT SWITCH (Four position switch)	S3	Electronic Assembly front panel 1. PLAYBACK LEVEL 2. RECORD LEVEL 3. BIAS 4. ERASE	Line output of recorder switched to tape playback. Meter reads output level. Line output of recorder switched to amplified record input signal. Meter reads output level proportional to the signal being recorded on the tape. A reading of "O" on the meter corresponds to normal recording level (1% distortion). Line output of recorder remains switched to amplified record input signal. Meter reads bias current. Line output of recorder remains switched to amplified record input signal. Meter reads erase current.
RECORD LEVEL	R9	Electronic Assembly front panel	Adjusts record level.

*When the SLOW START function is used, the capstan will not rotate until the START button is pressed.

SUMMARY OF CONTROLS, SWITCHES AND INDICATORS (Contd.)

<i>Item</i>	<i>Schematic Reference Symbol</i>	<i>Location</i>	<i>Function</i>
PLAYBACK LEVEL	R36	Electronic Assembly front panel	Adjusts reproduce level.
VU METER	M1	Electronic Assembly front panel	Provides a means for visually monitoring record input level, reproduce level, and bias and erase.
INPUT TRANSFER SWITCH	S1	Electronic Assembly front panel	Provides a means for selecting the appropriate input circuitry to record with a microphone or from a balanced or unbalanced line.
LINE TERM	S4	Electronic Assembly front panel	Controls output termination of the reproduce amplifier. In the ON position a 560 ohm resistor is across the output. In the OFF position, the resistor is out of the circuit and the amplifier must then feed a 600 ohm device.
START button	S805	Tape Transport Control Cluster	Starts tape in mode selected by the mode selector switch S802.
RECORD button	S804	Tape Transport Control Cluster	Controls record function of all electronic assemblies concurrently.
RECORD indicator	A802	Tape Transport Control Cluster	Lights only when <i>all</i> electronic assemblies have been energized by S804.
RECORD button	S6	Electronic Assembly front panel	Controls the record relay in the individual electronic assembly. Power is connected to the bias oscillator when this button is pressed. PLAY button must be pressed to put the tape in motion before the record button will have any effect.
FAST FWD REWIND PLAY mode selector switch	S802	Tape Transport Control Cluster	Provides a means to set the tape in motion for recording, reproducing, rewinding and fast forward modes.
STOP button	S803	Tape Transport Control Cluster	When this button is pressed, the brake solenoids and all relays are de-energized.

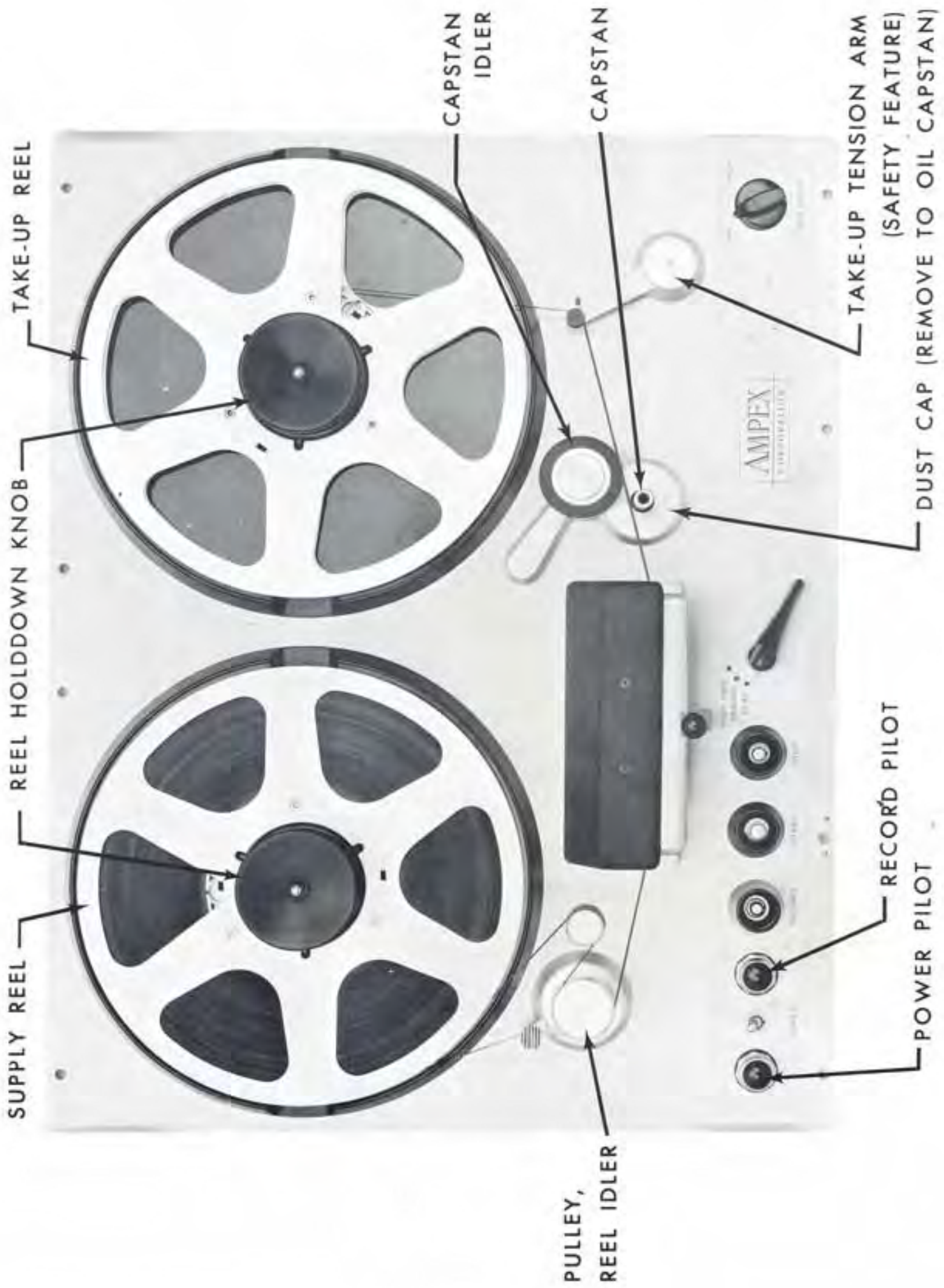

TAPE THREADING PATH

OPERATING TECHNIQUES

Threading the Tape

Thread the tape as shown in the illustration—TAPE THREADING PATHS. Unwind and inspect all new factory wound reels of tape by running them through in the FAST FORWARD mode.

New tapes might be looped to the hub in such a manner that the tape will not come free of the reel at the end. This will prevent the safety switch (S501) from disengaging the capstan idler and the capstan, which results in a flat being worn on the capstan idler wheel. (Any adhesive material accumulation on the reel hub may also keep the tap from coming free at the end of the reel, and should therefore be removed with solvent.)

Reel hold-down knobs, catalog number 9093 are furnished for ¼ and ½-inch tape equipment, and hold-down nuts, catalog number 5881 for 1-inch operation.

Power

Power to the tape transport and electronic assemblies is supplied through the main power switch S801 (each amplifier has a power switch S5).

Speed Switches

There are two switches associated with operating speed. The tape speed switch S503 determines the speed of the capstan drive motor, and the equalization switch 4S2 changes the equalization in the amplifiers appropriately.

Tape Motion

The tape motion is controlled at the tape transport control cluster by two push-buttons—PLAY and START, a mode selector switch—FAST FWD, REWIND and PLAY, a LOW-HIGH tape speed switch, and one other switch on the tape transport connector panel—FAST START/SLOW START.

FAST START/SLOW START switch S806 on the tape transport connector panel should normally be placed in the FAST START position when operating at all speeds of the Model 300. The capstan drive motor will then operate at all times when the tape is threaded.

With this switch in the SLOW START position, the capstan drive motor will operate only after the START button is pressed. This feature is provided so that the capstan motor will not operate if the equipment is to be left in a STANDBY condition for long periods.

LOW HIGH TAPE SPEED

The tape speed switch S503 determines the speed of the capstan drive motor and is used in conjunction with equalization switch 4S2.

START

To start the equipment in any mode of operation, press the START button S805.

PLAY OR RECORD

Tape motion during recording or reproduction is the same. Place the mode selector switch in the PLAY position and press the START button. The tape will start in motion at the speed selected by the LOW-HIGH TAPE SPEED SWITCH and reproduction will take place. Press the RECORD button to place the equipment in the record mode.

STOP

Pressing the STOP button causes all tape motion to cease, and shuts off recording by removing the power from the last stage in the record amplifier.

FAST FWD

To operate in the fast forward mode place the selector in the FAST FWD position and press the START button.

REWIND

Place the mode selector switch in the REWIND position and press the START button.

When editing or cueing the tape, the selector switch makes possible changing from fast forward to rewind (and vice-versa) without using the STOP and START buttons.

NOTE

In either fast forward or rewind on equipment using ¼-inch tape, it is desirable to remove the tape from direct contact with the heads by opening the head assembly gate.

Editing or Cueing

Indexing the tape as in editing or cueing, or when approaching the end of the reel, can be accomplished by switching the mode selector positions from FAST FWD to REWIND, reducing the tape motion to a slow travel and then depressing the STOP button when the desired point is reached.

Reproduce (Playback)

To reproduce a previously recorded tape, turn the METER and OUTPUT SWITCH 4S3, to the extreme left position designated PLAYBACK LEVEL, then start the tape in motion as indicated under PLAY. A PLAYBACK LEVEL Control 4R36 has been provided on the front panel to adjust the tape level to plus 8 vu output (zero on the vu meter)

Record

To record a new program on previously recorded tape, or on blank tape, turn the METER and OUTPUT SWITCH 4S3 to the second position from the left which is designated RECORD LEVEL. Turn the RECORD LEVEL CONTROL 4R9 clockwise until the level reads 0 (zero) on the vu meter on the most intense program peaks.

The program can be audibly monitored through either the phone jack (PHONES) 4J6, Monitor 5J4, or the line out connector (LINE OUTPUT) 5J5 before the tape is in motion. This direct monitor feature allows the program to be set up through the machine without actually recording during the set up period.

NOTE

For correct meter calibration it is important that the line out be properly terminated in a nominal 600 ohms either external to the machine or by the use of the line out termination switch (LINE TERM) 5S4.

When the record level has been set properly, place the mode selector in the PLAY position, start the tape in motion and press the RECORD button on the tape transport. The tape transport record indicator will light and the indicators on all electronic assemblies will light, indicating that all tracks are in the RECORD mode (concurrent recording).

If it is desired to record using only specific amplifiers, place the mode selector on the tape transport in the PLAY position and press the individual record buttons of the selected amplifiers. The record indicators on the amplifiers will light, but the tape transport record indicator will not light (even though all individual amplifier record buttons in the system have been depressed).

The erase position of the METER and OUTPUT SWITCH provides metering of erase current. The erase current is not critical and has been factory adjusted to read approximately zero on the vu meter. Both erase and bias current will vary directly with line voltage. The bias current is more critical and is factory set to read zero at 117 volt line voltage, using an average tape. It should read between $-\frac{1}{2}$ and $+\frac{1}{2}$ for the optimum high frequency response at $7\frac{1}{2}$ and $3\frac{3}{4}$ inch tape speeds using a median tape. For the flattest possible response with a given tape, the bias can be reset as described in Section 7—ALIGNMENT AND PERFORMANCE CHECKS. Note the bias current reading for this particular tape and log it for future reference.

The bias is adjusted by means of the Bias Control R460, located on the electronic chassis. The meter calibration for bias measurement can be checked as indicated in Section 7.

The record calibration control on this equipment has been adjusted so that a mid frequency input signal that produces a zero vu reading with the METER and OUTPUT SWITCH in the RECORD position will produce the 1% distortion level on an average tape. If it is desired to maintain a level with the METER AND OUTPUT SWITCH in the PLAYBACK position, proceed as follows:

- Step 1: With the METER and OUTPUT SWITCH in the RECORD position adjust the RECORD LEVEL control so that the vu meter reads zero on a steady mid-frequency signal.
- Step 2: Switch the METER and OUTPUT SWITCH to the PLAYBACK position
- Step 3: Adjust the PLAYBACK LEVEL control so that the vu meter reads zero

NOTE

Reproduce amplifier gain is approximately 2½ db lower in the 15 ips AME position than in the 7½ and 15 ips NAB positions. Therefore, when the level is to be monitored in the reproduce position, the PLAYBACK LEVEL control must be set to a higher setting in the AME position than in the NAB position.

Follow the above procedure for both AME and NAB equalization, marking the PLAYBACK LEVEL dial appropriately.

Separate Erase

Each track can be erased separately by placing the mode selector switch in the PLAY

position and, with no input to the record amplifier, pressing the START button, following with the RECORD button.

Half Track Operation (Dual Track Equipment)

Half Track recordings can be made on the 2-track equipment (with the exception of the 300-2M). Thread the blank tape to be recorded along the appropriate path, place the mode selector switch in the PLAY position, pressing the START button, following with the RECORD button of the amplifier and feeding the upper track (the track farthest from the tape transport). When the recording has been completed, press the STOP button and remove the reel of tape from the takeup side of the equipment, turn the reel over, and thread the tape along the proper path. *Again* press the RECORD button on the upper track amplifier.

THE DEVELOPMENT AND THEORY OF MAGNETIC TAPE RECORDING

There is no definite beginning to the history of magnetic recording but we can be certain that credit for building the first magnetic recorder belongs to Valdemar Poulsen. This Dan-



VALDEMAR POULSEN

ish telephone engineer who is often referred to as the "Father of Magnetic Recording" designed the microphonograph which was an invention of great scientific significance. In this apparatus a steel wire was moved with considerable velocity between the poles of a small electromagnet. By using this device a conversation could be permanently recorded for reproduction at any time.

In the early 1900's many scientists were attempting to use magnetic tape in preference to the earlier idea of wire. About 1927 a German inventor named PFlumer was experimenting with powdered coatings on tape. So far as we know he did not use magnetic oxide but coated his tapes with powdered metallic materials. Development continued and finally about the year 1939 the Germans produced a tape using a durable plastic backing. This began a new era in the improvement of magnetic tapes, culminating in the superior fidelity we all know.

To understand completely the uses and operating techniques of your Ampex Series 300 Tape Transport, the basic theory of Magnetic Tape Recording should be emphasized at this time . . .

THEORY OF MAGNETIC TAPE RECORDING

If a material capable of being magnetized is placed in the proximity of a magnetic field the molecules of that material will be oriented according to the direction of the field. Any of several methods may be used to produce a magnetic field, but of most interest in magnetic recording is the field produced by a current flowing through a coil of wire. The current itself may be derived from a transducer such as a microphone which converts the mechanical energy of sound to electric current.

Magnetic recording tape consists of finely divided iron-oxide particles deposited upon a plastic backing. During the recording process this tape is moved through a magnetic field in which the magnetizing force is alternating, and the iron oxide particles are aligned according to the instantaneous direction and magnitude of the field.

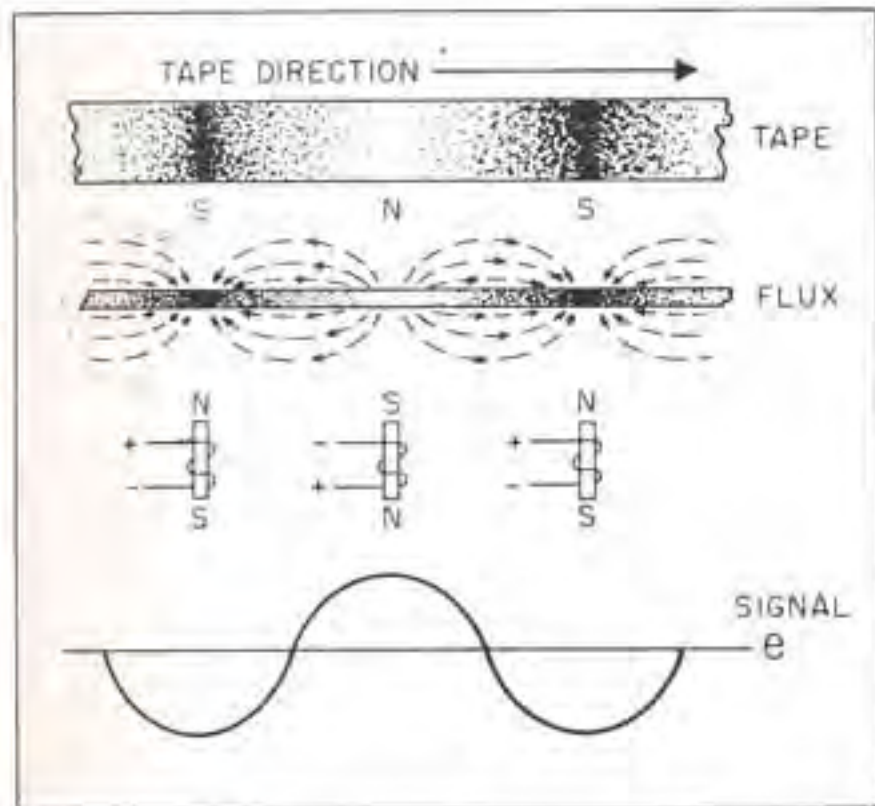

MAGNETIZATION OF TAPE

The magnetic field is produced in the gap of a recording head (which is essentially an electro-magnet) over which the recording tape passes. The head consists of an incomplete ring of highly permeable material inserted in a coil of wire. The discontinuity in the ring forms the gap, and the ring itself is the core of the electromagnet. The recording head and its gap thus constitute a series magnetic circuit.

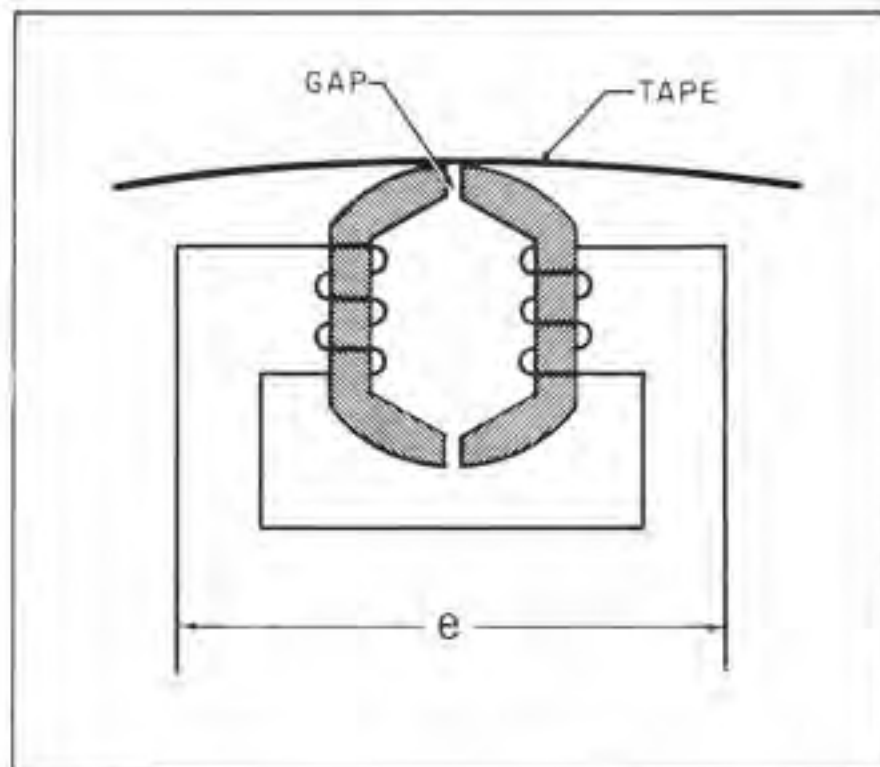

RECORD HEAD

The magnetization curve of the iron oxide used as the recording medium is similar to that shown as the heavy line in the illustration above.

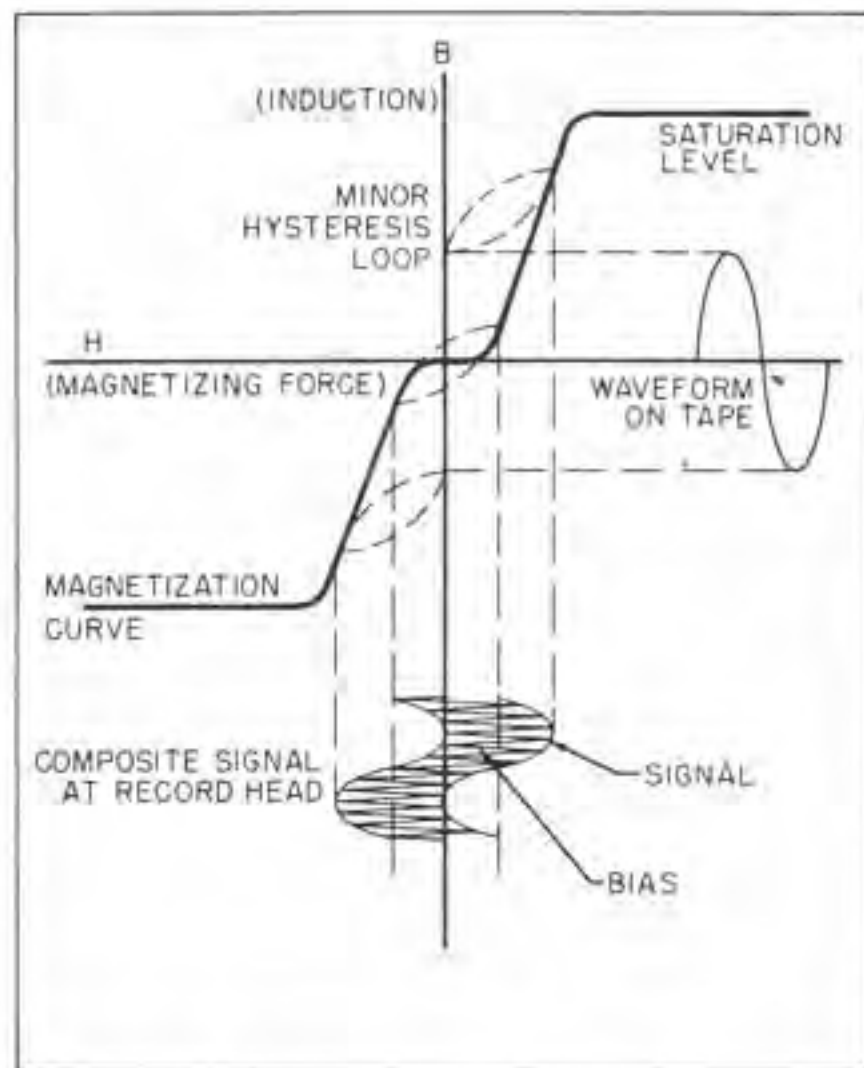

RECORDING MEDIUM MAGNETIZATION CURVE

At points near the origin the curve is extremely non-linear and, without some corrective factor, the signal recorded on the tape would not be directly proportional to the signal applied to the head, resulting in a high degree of distortion when the tape was reproduced. This distortion is greatly reduced by mixing a high frequency, constant amplitude, bias signal with the actual signal being recorded, so that operation is obtained on the linear portion of the curve. This may be likened to applying a d-c bias to a tube to force it to work on the linear portion of its curve. The bias signal is generally selected to be at least five times the highest frequency to be recorded so that no beating will occur between the bias frequency and the harmonics of the recorded signal.

While the tape is in the recording gap the bias causes the magnetization characteristics of the iron oxide to follow the dashed line loops known as the "minor hysteresis loops." As the tape leaves the gap the influence of the magnetic field created by the bias is reduced to zero and the tape assumes a permanent state of magnetization (known as "remanent induction") determined by the gap influx at that time.

After the recording process there exists on the tape a flux pattern which is proportional in magnitude and direction to the signal recorded. If the tape is then moved past a reproduce head—which is similar in construction to the record head—the magnetic flux on the moving tape will induce a voltage in the coil of the reproduce head. This induced voltage is proportional to the number of turns of wire on the head and the rate of change of flux. This is expressed by the equation $E = N(d\phi/dt)$

Where

E = induced voltage

N = number of turns of wire

$d\phi/dt$ = rate of change of flux

It is desirable that the gap in the reproduce head be as small as possible so it will intercept less than one wave length of the signal on the tape at the highest frequency to be reproduced. However, as the gap is made smaller the induced voltage decreases, so there is a practical limitation in decreasing the gap and still maintaining an adequate signal-to-noise ratio.

The voltage induced in the reproduce head during reproduction is computed by the equation $E = B_M V \text{SIN} \pi w / \lambda$

Where

E = induced voltage

B_M = maximum flux density of the recording material

V = velocity of tape over the head

w = width of the gap

λ = wavelength of the signal on the tape

From this equation it can be seen that the voltage across the coil increases directly as the velocity increases and as the wavelength decreases (frequency increases). If the tape velocity and gap width are assumed to be constant, the output voltage from the head is directly proportional to the frequency as long as the wavelength on the tape is large compared to the gap width. This results in an output vs. frequency characteristic such as is shown in curve A of the figure below.

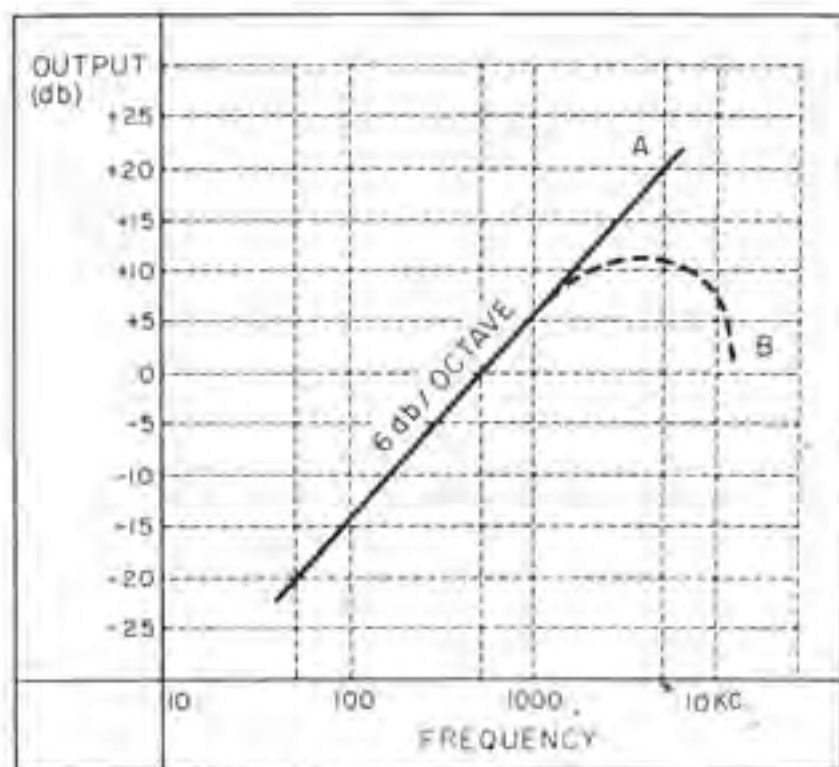

REPRODUCE HEAD CHARACTERISTICS

The voltage does not continue to rise indefinitely. As electrical losses in the core material increase and as the wavelength on the tape approaches the same dimensions as the reproduce head gap, the actual output resembles curve B in the same figure.

In order to provide an over-all frequency response that is flat (see the figure below) an equalization circuit consisting of a series resistance and capacitance is inserted in one of the early stages of the reproduce amplifier. The equalizing circuit has a high-frequency drop characteristic (curve B) which is the inverse of

the reproduce head characteristic curve A of above figure. In order to extend the high frequency response, additional equalization is included in the record amplifier in the form of a high frequency boost circuit designed to compensate for the droop in record and reproduce head characteristics caused by core losses, self-demagnetization of the tape at the short wavelengths and the wave length approaching the gap dimensions.

Disregarding the response of the associated amplifiers, the physical aspects of maintaining constant tape speed and good head-to-tape contact, and core losses in the head—all of which can be placed at a high performance level by good engineering design—there are certain inherent properties which define the frequency limits in recording and reproducing information on a specific magnetic tape recorder-reproducer. While these properties can be varied to meet differing requirements, the over-all result represents a compromise arrangement in which frequency response, signal-to-noise, and distortion are interrelated.

In this respect the high frequency response is primarily limited by the dimension of the reproduce head gap, and the frequency at which the head resonates with the capacity in the circuit.

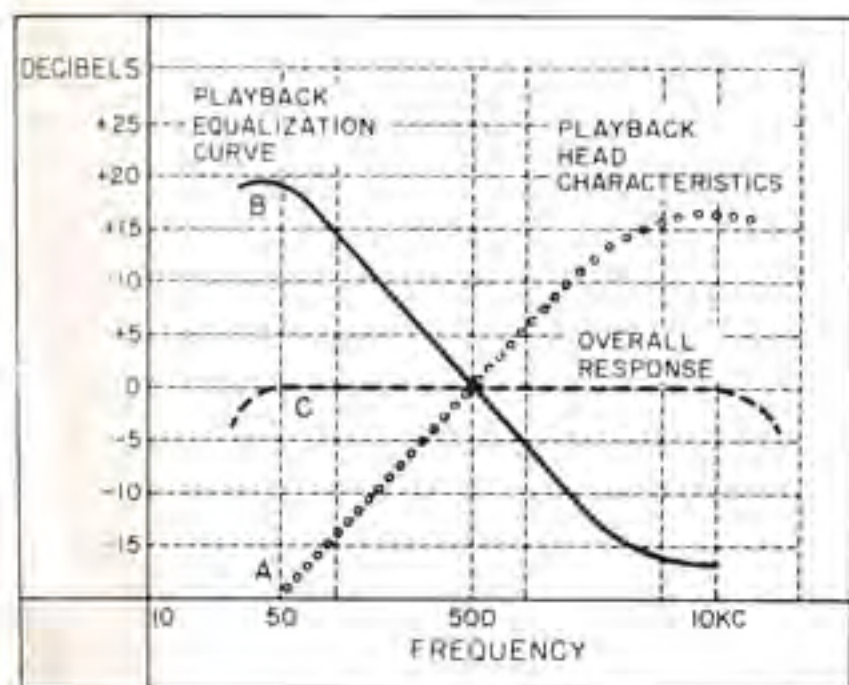

ACHIEVING FLAT OVERALL RESPONSE

During the recording process the tape assumes a permanent state of magnetization as it leaves the head gap, thus the record head gap width is relatively uncritical. However

in the reproduce mode the magnetic flux on the moving tape must induce a voltage differential across the reproduce head coil if a current is to flow in that coil. This induced voltage is attained as the flux travels through each branch of the head core, forced into that path by the high reluctance of the head gap. Therefore, an instantaneous difference in the magnitude of the moving flux must exist across the head gap to cause the flux to travel through the core and magnetically induce a voltage difference in the head winding.

When the recorded frequency rises to a degree where the reproduce head gap intercepts a complete wavelength of the signal (as it appears on the tape) there can be no difference in flux magnitude across the gap, and head output will reduce to zero. This cancellation effect will occur at multiples of the represented frequency, and for all practicable purposes the output is useless.

There are two means of counter-acting this "gap effect"—either the reproduce head gap width can be reduced or the record-reproduce tape speed can be increased. There are limitations in reducing the gap width and retaining adequate signal level and realistic manufacturing tolerances; as these limitations are reached any further extension of high frequency requirements must be accompanied by corresponding increases in record-reproduce tape speed. (In instrumentation applications it is also possible to record at a high tape speed and reproduce at a low tape speed, thus providing a signal expansion characteristic. For example: a 10 kc signal recorded at $7\frac{1}{2}$ ips, will reproduce as a 5 kc signal if the reproduce tape speed is $3\frac{3}{4}$ ips. This procedure of course cannot be used in standard audio applications where music or voice is recorded, and will result in the loss of the low frequency components of the signal.) Increasing the record-reproduce tape speed lengthens the wavelength of the signal as it appears on the tape, with the result that higher frequency wavelengths do not approach the gap dimension. (It also decreases the "self-demagnetizing" effect which occurs as the opposite poles of individual magnetic fields on the tape come closer and closer together.)

The resonant frequency of the inductance of the head coil and the capacitance—either actual or distributed—of its circuit must normally be

either outside the pass band of the system (so the drop in output following the point of resonance will not adversely effect the frequency response) or so placed at the extreme upper limit so that the increased output at the moment of resonance actually provides an extended response. When good engineering design has reduced circuit capacitance to an irreducible minimum, the only means of placing head resonance at a higher frequency is to reduce the inductance of the head coil by reducing the number of turns of wire. This adversely affects the output over the entire frequency range, and will particularly influence the low frequency limit.

Low frequency response is primarily determined by the relationship of the required signal-to-noise ratio, the characteristic curve of the reproduce head, the distortion which can be tolerated, and the bandwidth which must be recorded.

As previously explained the output of a reproduce head rises directly with frequency at an approximate 6 db per octave rate. Stated conversely, the reproduce head output drops directly with frequency at an approximate 6 db per octave rate. The low frequency limit is determined by how far this decreasing output can be tolerated while maintaining an adequate

signal-to-noise ratio. Thus, the noise generated by the associated electronic assemblies will have a definite effect on low frequency response. Increasing the record level to offset this decreasing output will eventually result in an increase in distortion.

Bandwidth is a determining factor in low frequency response because the 6 db per octave drop off in reproduce head output normally starts at the highest frequency which must be reproduced, and is constant regardless of tape speed. Thus as the upper frequency requirement is extended, the lower frequency limit—dictated by the required signal-to-noise ratio rises inexorably with it, octave for octave. A general rule is that the maximum bandwidth which can be effectively reproduced by any magnetic tape device is approximately ten octaves.

It should now be apparent that compromises are necessary in designing a magnetic tape recorder for a given purpose. If a high frequency requirement is imposed, then low frequency, signal-to-noise, or distortion must be limited (or perhaps a modulating-demodulating system employed which will effectively compress the bandpass requirements). Conversely, a low frequency requisite limits the high frequency response which can be obtained.

TAPE TRANSPORT MECHANISM

GENERAL

The tape transport mechanism provides tape motion for all modes of operation. Basic functions of the various assemblies are described in full and specifications of each are given throughout this manual. The assemblies and their associated components—the tape supply system, the tape takeup system, the tape drive system and control circuit—insures smooth, positive movement of the tape across the head assembly and proper tape tensioning when the equipment is in the record or reproduce modes. All tape motion controls, a Low-High tape speed switch, a takeup tension arm (safety micro-switch) and the head assembly are located on the tape transport.

CAUTION

When loading the tape from the left hand reel holder be sure the tape has the oxide-coated side toward the head faces.

TAPE SUPPLY AND TAKEUP SYSTEMS

From the supply reel, on the left side of the tape transport as the operator faces the equipment, tape is delivered to the takeup reel when the PLAY or FAST FORWARD mode is selected.

tape is rewound onto this supply reel when the REWIND button is selected. Proper tape tensioning is maintained during the record and reproduce modes by means of two reel induction torque motors, the supply reel idler, and reel idler guide arm (used only with ¼-inch tape).

The reel idler assembly on the supply side of the tape transport is composed of a pulley, a spring-pivot-mounted arm (only for ¼-inch machines) and a flywheel for the purpose of smoothing out transient speed variations in the tape system.

On the takeup side of the tape transport, the tension arm assembly with a spring-pivot-mounted arm forms a safety feature. Near the base of the shaft on which the tension arm is mounted, a drivelock pin actuates the safety switch (S501), stopping tape motion if the tape tension is lost for any reason (including tape breakage).

Both the tape supply and takeup assemblies are composed of induction torque motors (B601 Supply [Rewind], B701 Takeup), a turntable mounted directly on each motor shaft, a brake housing assembly and a flange for mounting the entire assembly. Because the brake housings are mirror images of each other, these assemblies are not interchangeable. The brakes are solenoid operated, remaining in the braking

position until the brake solenoids K601 and K701 are energized at which time the brakes are released.

During the reproduce or record modes, the two induction torque motors B601 and B701 act as tensioning devices (see *Tape Tensioning* in this section) and in the fast forward and rewind modes the motors respond to the commands from either push-button by operating at maximum torque in the selected function.

Tape Tensioning

The purpose of the Tape Tension System is to provide proper tape tension in all modes of operation.

The supply (rewind) and takeup induction torque motors are so connected that when power is applied with no tape threaded, the turntables, fixed to their shafts, will rotate in opposite directions. The tape supply turntable

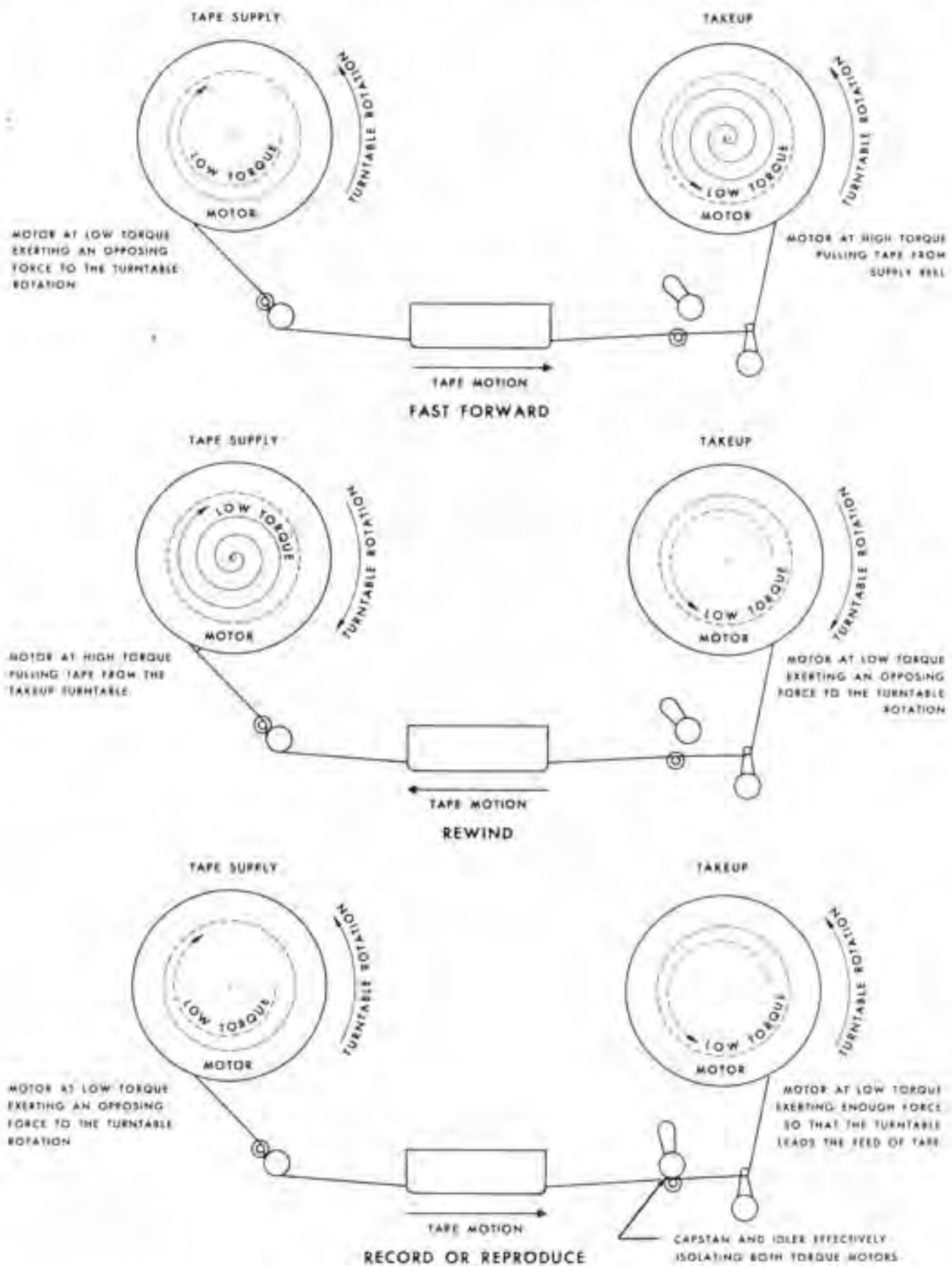

TAPE TENSIONING

will rotate clockwise, the tape takeup turntable will rotate counterclockwise.

Motor torque in the reproduce and record mode is adjusted to equality by the tensioning adjustment resistors (R801 HOLDBACK and R803 TAKEUP) in series.

In the fast forward mode, the torque of the supply (rewind) motor is reduced considerably by introduction of a series resistance (R802). In the rewind mode, R802 is in series with the take-up motor. Basic tape tensioning operation is shown in the illustrations.

In the fast forward mode, the take-up motor thus operates at full torque, the supply motor at reduced torque, and the tape is pulled from the tape supply reel. Because the torque of the tape supply turntable motor (rewind motor) is applied in the opposite direction to the turntable rotation, the tape is held under continuous tension as it is pulled from the reel.

In the rewind mode, the supply motor operates at full torque and the take-up motor holds the tape under continuous tension by its opposite and reduced torque.

In the reproduce or record modes, both torque motors operate at reduced torque. The tape drive capstan and the capstan idler, between which the tape is clamped, then determines the tape speed, and the tensioning system supplies tape or takes it up as metered by the capstan drive.

From the point of view of the tape supply turntable, the capstan and idler action exerts sufficient pull on the tape to overcome the opposing torque of the supply motor, which constitutes the hold back tension. From the point of view of the tape take-up turntable, the capstan and idler action is feeding the tape to it. The tape is held under tension here, because the take-up rate exceeds the feed rate (a tape loop will be thrown on the right side of the capstan whenever any malfunction causes the feed rate to exceed the take-up rate).

If a tape loop is thrown, or the tape breaks, the take-up tension arm will actuate the safety switch S501 and stop the equipment. The take-up tension arm is not a part of the tape tension system. Its function is to take up tape slack, especially when starting, and to operate the safety switch.

The reel idler assembly smooths out transients in the tension system. For example, when starting the tape in the reproduce mode, the momentary strain transmitted through the tape to the tape supply turntable, when the capstan idler forces the tape against the capstan, is considerable. Under some circumstances, this impulse tends to stretch or break the tape. A momentary decrease in hold-back tension might be sufficient to start a transient oscillation in the tape tension system which would be reflected as a periodic variation in the distance of the tape from the heads. This variation might be of sufficient magnitude to appear as an undesirable fluctuation in the signal level at the start of recording or reproduction. The reel idler arm absorbs most of the starting strain, and prevents or minimizes this type of oscillation. The reel idler pulley and flywheel provide additional stability in the tape tension system, by smoothing out such transients as motor torque fluctuations and irregularities due to faulty tape wrap on the supply reel. This is accomplished because the high inertia of the reel idler pulley and flywheel effectively isolate the reel assembly from the heads.

TAPE DRIVE SYSTEM

The tape drive system is composed of the drive motor, the capstan assembly, the capstan idler arm and idler, and the tape guides at the tape entrance and exit within the head assembly.

The purpose of the tape drive system is to transport the tape across the heads at a uniform speed during the record and reproduce processes. By means of a hysteresis synchronous capstan drive motor (B501), the tape drive capstan assembly and a capstan idler, the magnetic tape is driven at constant speed after power has been applied to the equipment and the PLAY button is pressed. (The drive motor has two windings to provide two tape speeds either of which can be selected at the TAPE SPEED toggle switch (S502 and S503).

After the POWER switch (S801) at the electronic assembly and tape transport has been placed in the ON position the FAST or SLOW start switch (S806) is at this time operated. In the SLOW start position the capstan drive motor is out of the circuit but in FAST start the capstan drive motor solenoid energizes and the

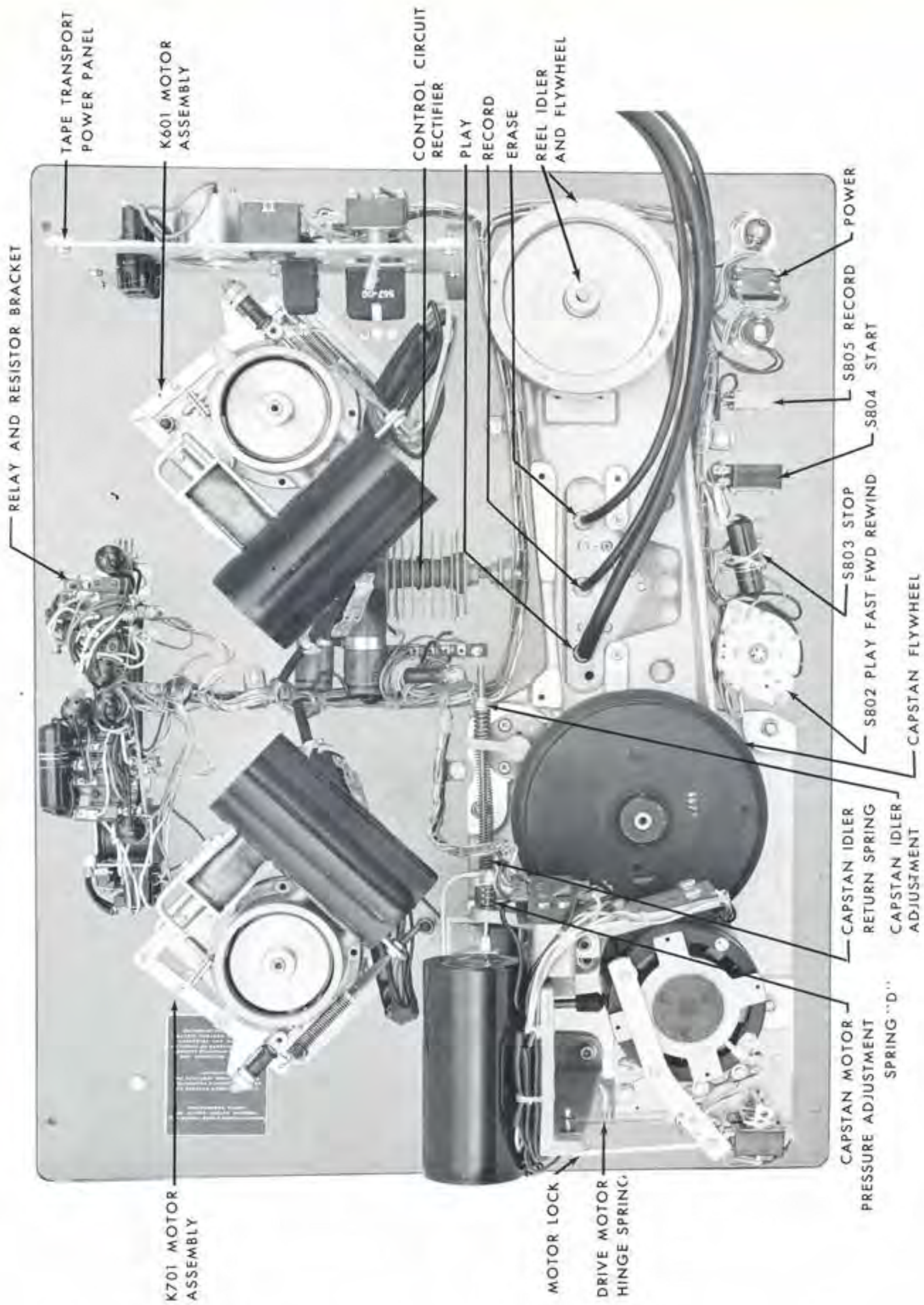

BOTTOM VIEW, TAPE TRANSPORT

motor pulley engages the capstan flywheel. When the PLAY position is selected, followed by pressing the START button, (provided the tape is properly threaded), the capstan solenoid (K501) and the brake solenoids K601 and K701 are energized. The capstan solenoid pulls the rubber tired capstan idler wheel, which is mounted on a swivel type arm, against the tape, causing the tape to make firm positive contact with the capstan. The tape is then driven at a constant speed across the head assembly.

The capstan drive motor assembly is mounted on a sturdy motor bracket held to the underneath side of the tape transport with three $\frac{1}{4}$ -20x $\frac{3}{8}$ socket head cap screws. Mounted on top of the motor is the spring arm with variable holes for the drive motor return spring whether it be rack, portable or console (horizontal or vertical mounted). Two holes for the shipping lock also share this spring arm. The purpose of the spring is to provide a means to keep your motor pulled away from the capstan in the de-energized position. A stronger return spring is required for rack mounted machines than for console or portable units.

Rack—A-19995-01 (Heavier)

Console—A-19994-01

The capstan drive motor is mounted on a hinge which is moved by a solenoid to engage the motor and capstan flywheel. Extending from the solenoid draw bar is an adjustment point listed on the illustration.

The capstan speed should be checked with the stick-on strobosticker provided. Before checking, let drive unit run for at least five minutes to warm up lubricant in the capstan assembly. If the lubricant is stiff, the additional drag will cause greater compression of the rubber tire and the capstan will therefore run slightly slow until warmed up. Place strobosticker on capstan shaft with the sticky side down and view rotating shaft under 60 cps light. If the speed is not correct the spokes will appear to rotate. Slight speed changes can be realized by change in capstan drive motor pressure. If the adjustment is in the proper range, increasing pressure will slow the capstan, decreasing pressure will speed the capstan. Adjust for no rotation of the strobosticker spokes. (If drive motor pressure is too light, increasing pressure will speed the capstan. In this range

the tire pressure is inadequate for stable operation, and the pressure should be increased until increase in pressure reduces capstan speed.)

BRAKE OPERATION

Smooth brake operation is extremely important in maintaining proper tape tension when stopping the tape. Because the holdback tension, supplied by the trailing turntable motor torque, is lost after the STOP button is pressed, maintenance of tape tension then becomes a function of brake operation. The braking force acting on the turntable from which the tape is being pulled (trailing turntable) in any of the modes of operation must exceed the braking force acting on the turntable taking up the tape (the leading turntable) to prevent the throwing of tape loops.

One end of the brake band is fixed to the cross head by a roll pin ($\frac{1}{8}$ inch x $\frac{3}{4}$ inch) and two 4-40 x $\frac{1}{4}$ inch socket head cap screws which is attached to the anchor mounted on the brake housing. The other end is linked to the brake lever by a $\frac{1}{8}$ inch x $\frac{1}{2}$ inch drivelock pin and is free to move. When the brake solenoid is de-energized, the brake tension spring acting on the brake lever draws the brake band against the brake drum.

For example if the brake drum of the supply motor, as viewed from the brake housing end, is rotating clockwise when the brake band is applied, the frictional force will cause the band to wrap itself tightly around the brake drum, the brake lever end of the band moving to the right thus increasing braking force. When the drum is rotating counterclockwise, the process is reversed, causing the band to pull away from the drum, and decreasing the braking force.

The ratio of the braking force in one direction to the braking force in the other—the brake differential—is approximately two to one on this equipment.

In all modes of operation, the greater braking force always acts on the trailing turntable, maintaining the tape under tension as the system is stopped.

CONTROL CIRCUIT

The control circuit contains all switches and relays which control the operation of the tape

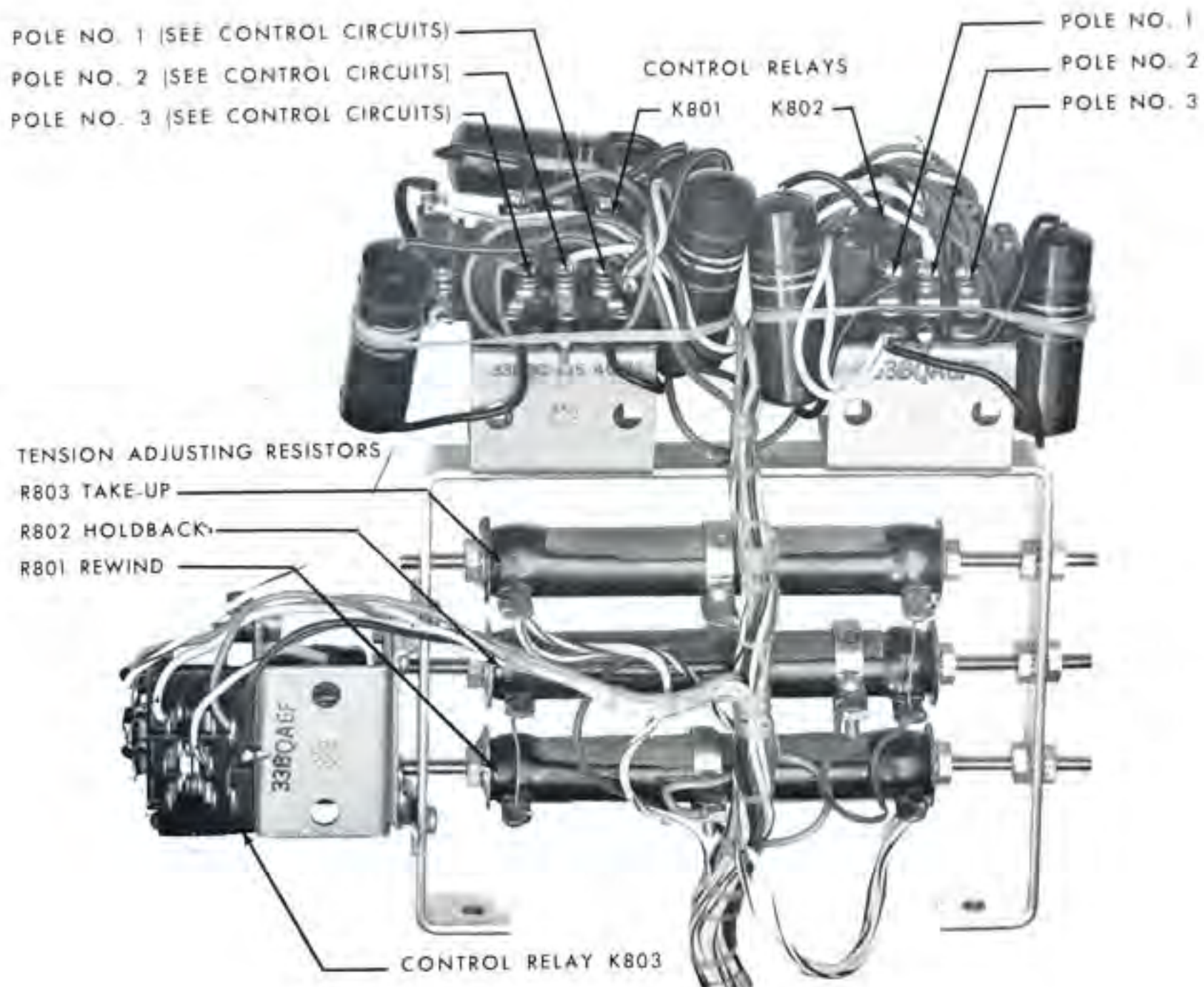

RESISTOR AND RELAY BRACKET

transport in all modes. Located underneath the transport, between the supply and takeup motor assemblies, is the bracket supporting rewind resistor (R801), takeup resistor (R803) and series resistor (R802). Also mounted on this bracket are three relays—PLAY RELAY (K801), MODE RELAY (K802) and FAST START RELAY (K803). All electronic components such as capacitors and resistors are shown in the foldout illustration, Tape Transport Control Circuits. There are three motor starting capacitors, the capstan solenoid, the brake solenoids, and the safety microswitch mounted adjacent to the assemblies they serve.

Located underneath the tape transport is the control panel which is the source of power for the tape transport and electronic assemblies.

When a Model 375 or remote control are not used two dummy plugs must be inserted into the appropriate sockets. These plugs are catalog No. 567 (60 cycle amplifier), 8-pin Jones plug, with pins 1 and 2 jumpered and pins 7 and 8 jumpered.

1. One No. 567 must be plugged into receptacle J804S, labeled, "Remote Control or Plug A367" located on the connector panel. It is removed only when remote control is desired and the remote control cable must then be plugged into the receptacle.

2. The other No. 567 must be plugged into receptacle J805S labeled "Cable to Model 375—60 Cycle Amplifier". When the Model 375 is used with the recorder, the input-output

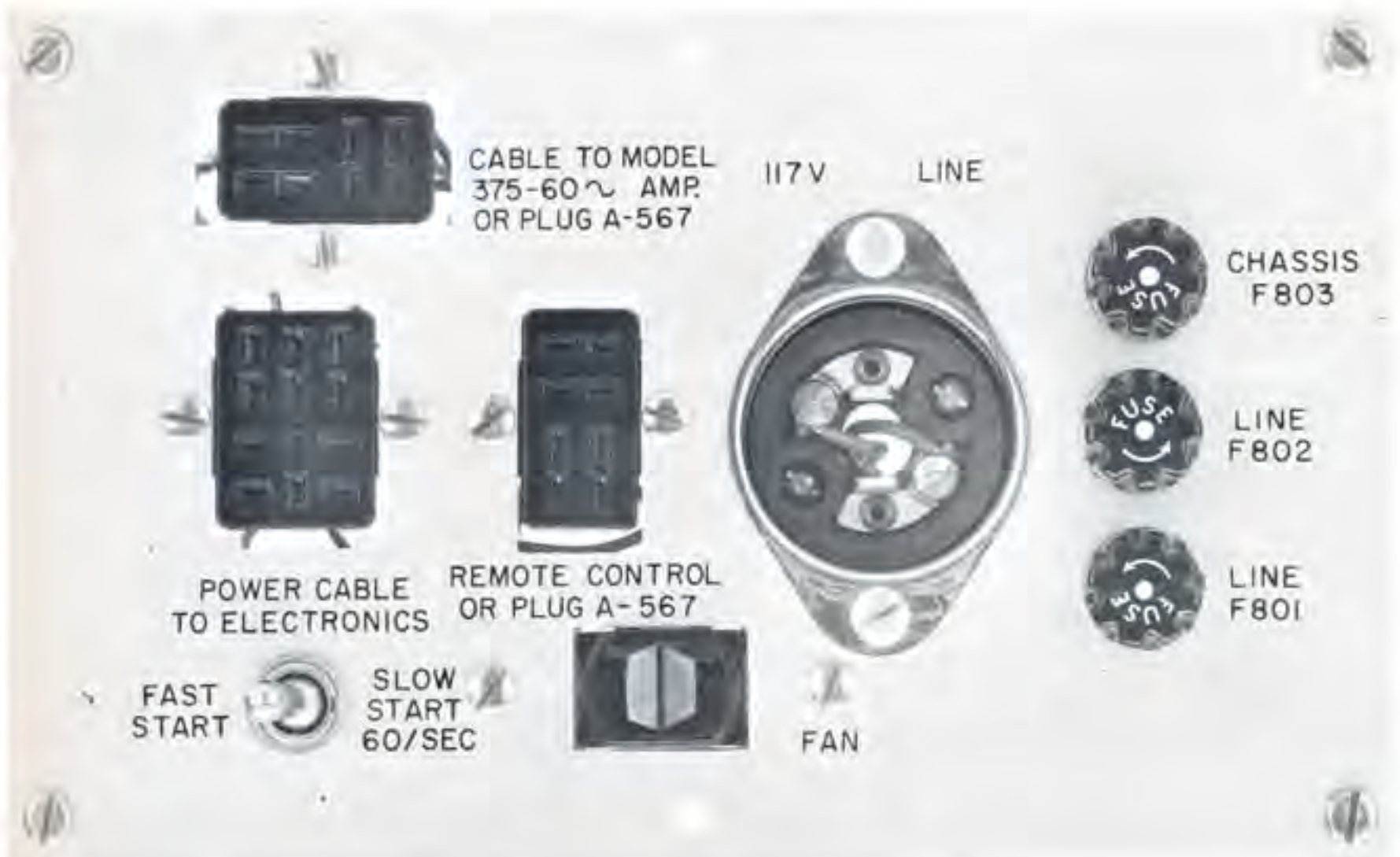

POWER PANEL, TAPE TRANSPORT

cable from the 375 is plugged into the receptacle.

Fuse Requirements For Multichannel Tape Transport Power Panel

Fuse F803—3 amp.	
Fuse F802—5 amp.	2 and 3 channel
Fuse F801—5 amp.	
Fuse F803—3 amp.	
Fuse F802—6 amp.	4 channel
Fuse F801—6 amp.	

All function control of the tape transport, with one exception, takes place at the control circuit switch assembly comprising three push-buttons START, STOP and RECORD, and three position selector switch choosing one of three modes at a time: PLAY, REWIND and FAST FORWARD. Two toggle switches POWER and TAPE SPEED (selector type knob) are mounted at either end of the control cluster. The safety switch (not an operating control) is mounted under the tape transport.

Rewind

Power has been applied by Power Switch (S801) and Indicator Light (I801) is lighted. When REWIND mode S802-B is selected and the START button pressed MODE relay K802 is energized and held in this condition by relay contact sets K802-B and the normally closed STOP button S803. Contact set K802A connects full a-c power directly to the rewind (supply) motor. The rewind motor operates at full torque and the takeup motor at reduced torque, thus tape is pulled at a maximum speed from the takeup to the rewind reel assembly, thus releasing the brakes.

Fast Forward

Power has been applied by Power Switch (S801) and Indicator Light (I801) is lighted. When FAST FORWARD mode S802C is selected and the START button pressed, (S805), MODE relay K802 is energized and held in this condition by relay contact sets K802-B and the normally closed STOP button S803. Contact K802A connects full a-c power directly to the

takeup motor. The takeup motor now operates at full torque and the rewind motor at reduced torque, causing the tape to be pulled at a maximum speed from the rewind to the take-up reel. Contact set K802-C completes the d-c circuit to the brake solenoids at each reel assembly, thus releasing the brakes.

Stop

When the tape is moving in any mode and the STOP button (S803) is pressed, the brake solenoids, and all relays are de-energized. The brakes are applied to both turntable motors. The capstan drive motor, however, will continue to operate so long as the tape remains properly threaded.

Play

Power has been applied by Power Switch (S801) and Indicator Light (I801) is lighted. When PLAY mode (S802-A) is selected and start button (S805) is pressed PLAY relay (K801), MODE relay (K802) and FAST START relay K803 (only in Fast Start Position) are energized. Contact sets K802B, K801B and normally closed STOP button (S803) form a holding circuit. Power is connected to the turntable reel motors through contact K802A through contact K802C power reaches the brake solenoids K701 and K601. The reel motors are powered and the brakes are released simultaneously, causing the equipment to operate in the reproduce mode at the speed selected by the TAPE SPEED SWITCH (S503).

Record

Power has been applied by Power Switch (S801) and Indicator Light (S801) is lighted. The RECORD button (S804) is pressed only after the PLAY mode (S802A) has been selected and the START button (S805) pressed. Record Lamp (I802) will then light.

Fast Start

When power has been applied to the tape transport by turning POWER SWITCH (S801) to the ON position, and the TAPE SPEED SWITCH (S502) in the FAST START POSITION (S806), the capstan solenoid K501 and drive solenoid K502 have been energized and effectively engages the capstan motor pulley

with the capstan flywheel. Now by this engagement, the capstan will rotate continuously in all modes of operation until the POWER SWITCH (S801) is switched to the OFF position.

Slow Start

When power has been applied to the tape transport by turning POWER SWITCH (S801) to the ON position, and switch S806 to the SLOW START position, the capstan solenoid K501 and drive solenoid K502 are de-energized which leaves the capstan motionless. The PLAY position is then selected and the START button pressed which puts a-c to the capstan motor. The capstan solenoid K501 and drive solenoid K502 are then energized and engages the capstan motor pulley with the capstan flywheel. (Special applications sometimes require a tape speed of 60 inches per second. SLOW START must be used at this speed.)

Safety Interlocks

When the tape is moving in either of the high speed modes (fast forward or rewind), it is not possible to switch to the play mode without first pressing the STOP button. If this is done the circuit is broken at the selector switch S802 and the tape transport stops all tape motion. The START button S805 must then be pressed to start tape motion again.

CAUTION

If the STOP and PLAY buttons are pressed in too rapid a sequence when the tape is in either high speed mode, tape will almost invariably be broken or deformed. Always allow time for the tape to stop completely when switching from either of the fast modes to PLAY.

ROUTINE MAINTENANCE

Carefully follow the routine maintenance program outlined below if proper performance is expected of the equipment at all times. Keep an Operation and Maintenance Log.

Cleaning

Clean the capstan, the head faces and tape guides daily. Clean the capstan idler wheel weekly. Great care must be taken to see that oil does not reach the rubber tire. Avoid, as much as possible, touching the tire with fingers.

The agent for cleaning Ampex head assemblies is a mixture of Xylene and 0.1% Aerosol, and is available in 4 oz. bottles (Ampex Catalog N. 087-007). Other solvents can have detrimental effects on these precision parts. To clean any head assembly, wind a clean, lintless cloth on a wooden swab-stick and moisten with this mixture. Swab the heads to remove all dirt and accumulated oxide deposited from tape.

CAUTION

Do not use any other solvents as there are some which may damage the laminations of the head assembly. Do not use metal swab-sticks.

Cleanliness of all parts of the tape drive mechanism is required for consistent optimum performance. Clean all parts except the head assembly using a lintless cloth moistened with denatured alcohol. This cleaning is of particular importance because most tape manufacturers lubricate their tapes, and the lubricant will gradually form a coating on the components in the tape threading path which will result in a loss of positive drive at the capstan, flutter and wow, signal drop-outs or poor high frequency response.

Lubrication

The following parts of the tape transport mechanism require lubrication every three months, or every thousand hours of operation, whichever occurs first.

Capstan Drive Motor Lubrication

Lubricate the upper sleeve bearing of the capstan drive motor with this oil or its equivalent:

Caloil OC-11 (Ampex Catalog Number 087-005) Standard Oil Company, San Francisco, California.

Class "C"

Medium turbine oil, petroleum base with inhibitor additives to increase oxidation and corrosion preventive properties. Essential characteristics are as follows:

Characteristics:	Required (Limit)
Viscosity in Centistokes	
at 130° F	40.0-48.0
Pour Point	25° F (max.)
Flash Point	370° F (min.) ±20° F

To lubricate the drive motor locate the two oil cups extended from each motor end bell. Place into each oil cup not more than 4 drops of the recommended lubricant (OC-11).

CAUTION

Do not over lubricate. Wipe off excess oil.

Capstan Idler Lubrication

Gently pry the dust cap from the wheel hub (a knife blade can be used), and oil with not more than 3 drops of OC-11 oil, on the felt washer. Failure to perform capstan idler lubrication can result in the felt washer becoming completely dry, and a dragging idler can contribute to flutter.

CAUTION

Do not overlubricate or the wheels will throw oil in operation. If oil spills on rubber tire, clean it immediately with ethyl alcohol.

NOTE

The reel idler assembly, the takeup tension arm assembly and the takeup and rewind motors contain permanently lubricated bearings, and require no further lubrication.

Capstan Assembly Lubrication

When lubricating your Capstan Assembly a note of caution should be made in regard to an overload of lubricant. The capstan is one

of the most important functioning assemblies on your tape transport, and its smooth operation will ensure long life of your machine.

To lubricate remove the capstan idler by loosening the set screw in the capstan arm. Loosen the set screw in dust cap and remove the cap. Remove the felt washer and fill the small hole in the capstan upper bearing with the prescribed oil (OC-11). Reinstall the felt washer, dust cap and capstan idler by retightening the set screws in both the dust cap and capstan idler arm.

NOTE

This lubricating process is imperative at least once every three months using the oil prescribed above. If an excess of oil has been added wipe off to prevent the throwing of oil in operation.



DEMAGNETIZING THE HEADS

Head Demagnization

Occasionally, the heads may become permanently magnetized through electrical faults in the amplifiers, improper use of the equipment, or by contact with magnetized objects. Magnetized heads will cause an increase of 5 to 10 db in background noise level, and can impair good recordings by partially erasing high frequencies. The full dynamic range of the equipment cannot be realized if the heads are magnetized.

Any phenomena that tend to put large un-

balanced pulses through the record head will magnetize it. Observe these precautions and no difficulty should be experienced.

Do not remove any tube from the record amplifier while the equipment is recording. Do not connect or disconnect the input leads or the head leads while recording.

Do not saturate the record amplifiers with abnormally high input signals. Such signals would be 10 db greater than tape saturation or approximately 30 db greater than normal operating level.

If it becomes necessary to check the continuity of the playback or record heads with an ohmmeter they must be demagnetized after checking. The erase heads are self demagnetizing.

If the heads become magnetized, proceed as follows, using an Ampex Demagnetizer, Catalog No. 704:

- Step 1: Place the equipment power switch in the OFF position.
- Step 2: Plug the demagnetizer into a 117-volt a-c source.

NOTE

If the plastic coating wears off, place one layer of electrical friction tape on the demagnetizer tips. Scratching heads will then be prevented.

- Step 3: Bring the tips of the demagnetizer to within approximately 1/8-inch (if the demagnetizer tips are taped or covered, contact with the heads can be made) of the record head core stack, straddle the head gap and draw the demagnetizer tips up and down the length of the core stack three or four times.
- Step 4: Remove the demagnetizer slowly from the head stack to a distance of 3 or 4 feet, thus allowing its a-c field to diminish gradually. This slow removal is extremely important.

CAUTION

Do not unplug the demagnetizer while it is near the heads: the collapse of its magnetic field will re-magnetize the head.

Step 5: Repeat Steps 3 and 4 at the reproduce and erase heads.

Step 6: If necessary, repeat the process till complete demagnetization is effected in each case.

If the capstan, tape guides or other metal parts become magnetized, a few passes of the demagnetizer along their lengths and the slow withdrawing technique should be adequate.

ADJUSTMENTS

The mechanical assembly is shipped from the factory with all adjustments set for correct performance. It should be unnecessary to change any adjustment before putting the equipment into service, unless shipping damage has occurred. In the course of wear in normal service, or in the event of component failure, and replacement of parts, some readjustments may be necessary.

Equipment Required:

- Spring Scale 0-16 oz.
- Spring Scale 0-80 oz.
- $\frac{3}{8}$ -inch Nut Driver
- 3 16-inch Screwdriver
- Nylon Lacing Twine or Strong String
- 7 16-inch Socket Wrench
- 5 64-inch Allen Wrench

Takeup and Supply (Rewind) Tension

Takeup and Supply tensions are determined by the positioning of the sliders on resistors R801 and R802 located on the relay and resistor bracket on the underneath side of the tape transport. Resistor R802, on the same bracket, is set for maximum resistance to obtain $\frac{1}{2}$ ounce to 1 ounce holdback tension in the fast modes of $\frac{1}{4}$ -inch and $\frac{1}{2}$ -inch machines. With 1 inch machines the slider is set for minimum resistance to obtain 1 ounce to 2 ounce holdback tension in the fast modes.

The torque of both the rewind and takeup motors must be adjusted to the following set adjustments: with a 16 ounce spring scale at NAB reel hub diameter.

For $\frac{1}{4}$ -inch versions set for 6 to 7 ounces.

For $\frac{1}{2}$ -inch versions set for 8 to 10 ounces.

For 1 inch versions set for 12 to 15 ounces.

With the following step by step methods of measuring the torque of the takeup and supply motors no problems should arise in having per-

fect functioning of your tape motion. Included with these methods are illustrations and step by step procedures of adjusting the brakes of the takeup and rewind assemblies. Both of these are important in obtaining smooth performance from your tape transport at all times.

Step 1: Place an empty 10 $\frac{1}{2}$ inch NAB reel on the tape supply turntable.

Step 2: Place the POWER switch in the ON position.

Step 3: Hold the takeup tension arm so that the safety switch is activated (a rubber band or piece of masking tape will hold the arm as though the tape were threaded on the equipment.)

Step 4: Make small loops at both ends of a thirty inch piece of nylon lacing twine.

Step 5: Attach one loop to the tape anchor on the reel hub and the other to a 0 to 16 ounce spring scale or equivalent.

Step 6: Depress the PLAY button and allow the clockwise motion of the supply reel (torque motor tension) to draw a turn of twine onto the hub.

Step 7: Make certain that the twine is now parallel to the plane of the top of the tape transport and that the twine is centered and not touching either reel flange.

Step 8: Now let the torque motor pull the twine slowly onto the hub by following the torque motor force with the scale.

Step 9: Using this "following" technique, observe the readings on the scale until a constant reading is obtained.

Step 10: If necessary adjust the slide on resistor R801 on the resistor and relay bracket until the desired reading is obtained.

Step 11: Use the procedures in the preceding steps to check and adjust the takeup tension which is set at R803 (note that the reel on this side will move counterclockwise).

Brake Adjustment

Brake adjustment is made (with no power applied to the equipment) at the point shown in the illustration.

- Step 1:** Place an empty 10½ inch NAB reel on the tape supply turntable.
- Step 2:** Make small loops at both ends of a thirty inch piece of nylon lacing twine.
- Step 3:** Attach one loop to the tape anchor on the reel hub and the other to a 0-16 oz. spring scale for ¼ inch machines and 0-32 oz. spring scale for ½ and 1 inch machines.
- Step 4:** Manually rotate the reel clockwise to wind several turns of twine onto the hub.
- Step 5:** Pull the scale, making certain that the

twine does not touch either flange of the reel. The turntable will rotate counterclockwise. Take a reading only when the turntable is in steady motion, because the force required to overcome the static friction will produce a false and excessively high initial reading.

- Step 6:** Adjust the supply and takeup motors brakes for scale readings listed below. Points of adjustment are shown by illustration.
- Step 7:** Now wind the twine on the hub by rotating the reel counterclockwise; pull, and take a reading. The turntable will rotate clockwise.
- Step 8:** Repeat the entire process on the take-up turntable.



BRAKE ADJUSTMENT, LOW SIDE



BRAKE ADJUSTMENT, HIGH SIDE

SPRING SCALE READING

<i>Tape Width</i>	<i>Direction of Most Resistance Supply Counterclockwise Takeup Clockwise</i>	<i>Direction of Least Resistance Supply Clockwise Takeup Counterclockwise</i>
¼ inch	15 to 16 ounces	2:1 ratio ±1 ounce in accordance with the High Side
½ inch	19 to 20 ounces	2.5:1 ratio ±1 ounce, etc.
1 inch	22 to 24 ounces	3:1 ratio ±1 ounce, etc.

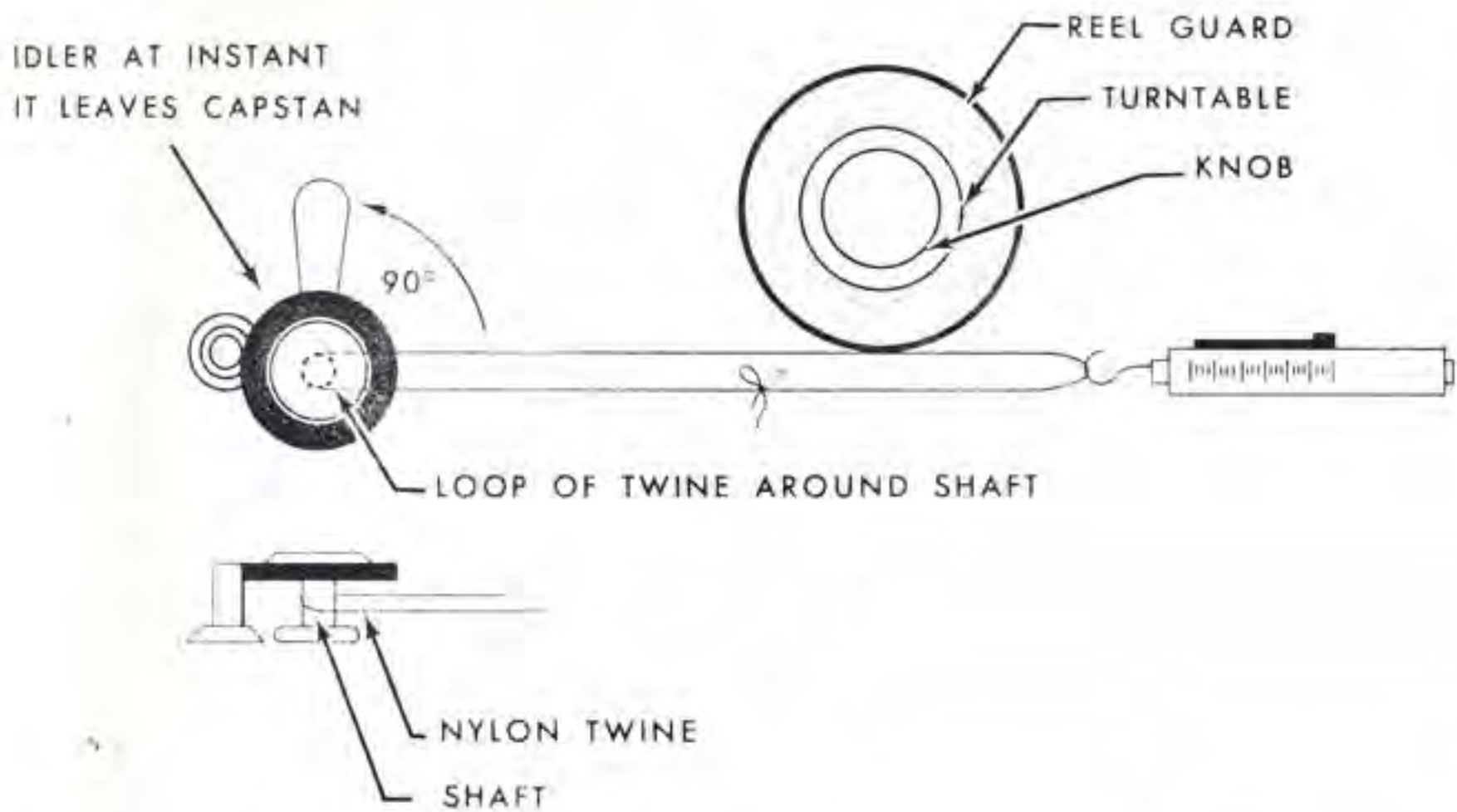

CAPSTAN IDLER PRESSURE MEASUREMENT

Capstan Idler Pressure

The capstan idler is forced against the capstan by the action of the capstan solenoid spade bolt. See the illustration. Tightening the lock nut increases idler pressure until a point is reached where the solenoid will not bottom. At this point, idler pressure drops to a value which is inadequate to permit the capstan to drive the tape, and slippage will occur unless the nut is backed off. Excessive pressure also throws an unnecessary load on the upper sleeve bearing of the drive motor and causes a considerable lax in that speed being operated. The recommended procedure for adjusting idler pressure is as follows:

- Step 1: Hold the takeup tension arm so that the safety switch is activated.
- Step 2: With the POWER switch in the ON position, press the PLAY button, and note whether the capstan solenoid is bottomed. (The capstan idler can be pushed off the capstan easily by pushing on the idler arm, if the solenoid is not bottomed). If necessary, back off the lock nut until the solenoid does bottom at 90 volts a-c when cold, or 105 volts when warm (after ½ hour

running). The pressure ("dig") against the capstan shaft should be $5 \pm \frac{1}{2}$ pound.

NOTE

In the course of normal operation in the reproduce or record modes, the temperature of the capstan solenoid will rise, and its d-c resistance will increase. Therefore, the minimum line voltage required to bottom the solenoid when it is hot will be greater than that required when it is cold. If the equipment is operating on unusually low line voltage below (100 to 105v.), sometimes encountered in areas where regulation is poor, the solenoid may fail to bottom after it has reached normal operating temperature. It is advisable, therefore, to allow the equipment to operate in the reproduce mode for about half an hour before making any necessary solenoid adjustments. This will allow the widest margin of safety with respect to line voltage variations. The solenoid is factory-adjusted to bottom at 90 line volts cold and 105 line volts hot.

- Step 3:** If it is desired to measure capstan dig, press the STOP button at this point and select a piece of nylon lacing twine about 30 inches long and tie the ends together.
- Step 4:** Slip the twine loop just formed between the idler and idler arm so that the nylon rests against the idler shaft.
- Step 5:** Attach the other side of the loop to a 10 pound scale, letting the nylon twine remain slack.
- Step 6:** Press the PLAY pushbutton, causing the capstan idler to clamp against the capstan.
- Step 7:** Pull the scale away so that the nylon twine is taut and makes a 90 degree angle with the idler arm.
- Step 8:** Now, slowly pull the scale away with sufficient power to cause the capstan idler to leave the capstan, reading the scale at the instant the capstan idler leaves the capstan. The scale reading should be 5 lbs. $\pm 1/2$ lb. If necessary, adjust the capstan dig at the point shown in the illustration.

Replacement of Parts

All sub-assemblies of the tape transport mechanism can be easily dismantled with the use of a screwdriver and a few small socket head screw keys.

CAUTION

Do not attempt complete disassembly of any of the sub-assemblies. The list of individually replaceable parts under each assembly listing in the parts list should be used as a guide to disassembly limits. Replacement of parts other than those listed calls for precision work which should not be attempted in the field. Assemblies with defects in parts other than those listed as replaceable should be returned to the factory or to an Ampex authorized service center for repair or replacement.

Write the Service Department for a proper authorized equipment return tag. Do NOT ship unidentified parts to factory. Ampex can assume no responsibility for their proper care or return under such circumstances.

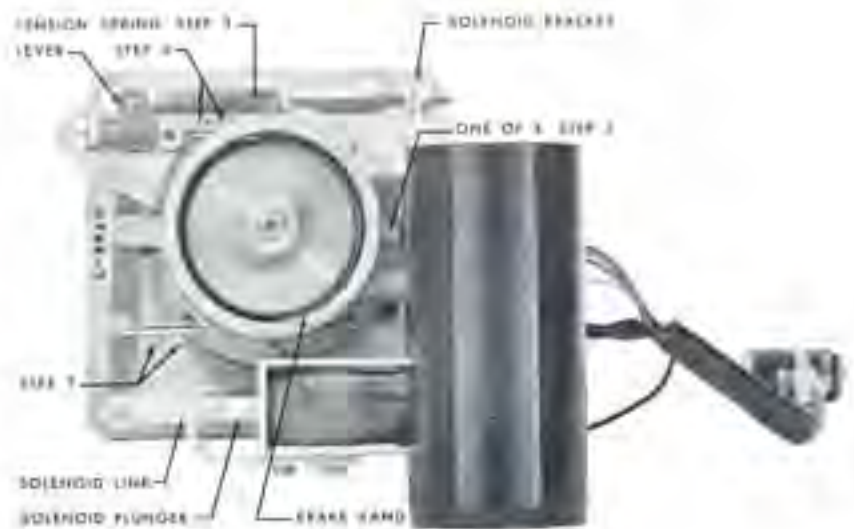

BRAKE BAND REPLACEMENT

Brake Band Replacement

NOTE

Brake Bands may be replaced without removing motor from tape transport on rackmount machines and deleting the first three steps.

The most convenient method for changing the brake band is first to remove the entire motor assembly.

- Step 1:** With a 7/16-inch socket wrench remove the four mounting screws and washers at the motor mounting plate, carefully holding the motor with one hand to prevent it from falling. The turntable will remain attached to the motor assembly.
- Step 2:** Take the motor to a convenient work area.
- Step 3:** Unhook the brake tension spring from the brake lever.
- Step 4:** Remove the two screws holding the capacitor. Disconnect the capacitor wires at knife disconnects and free the capacitor from the bracket.
- Step 5:** Remove the screws that hold the brake housing to the motor, noting the positioning of the washers, and spacers and remove the entire housing.
- Step 6:** Remove the two cap screws holding one end of the brake band between the brake lever spring and the housing using a 5/64-inch Allen wrench.
- Step 7:** Loosen (do not remove) the two cap screws at the end of the brake band next to the solenoid.

- Step 8:* The brake band may now be removed taking caution not to lose the band leaf on the solenoid side. There is only one band leaf per assembly.
- Step 9:* Position the new brake band through the hole in the housing and place between the clamp and tighten the two cap screws loosened in Step 8.
- Step 10:* Replace the brake housing, making certain that the spacers, the housing, the washers and the screws are replaced in that order, and tighten the screws.
- Step 11:* Insert the brake band between the band link and band link clamp. Replace the two cap screws but **DO NOT TIGHTEN**.
- Step 12:* Push the solenoid in until it bottoms. Adjust the depth of insertion of the brake band between the link and clamp so that the brake drum rotates freely with no drag; then, tighten the screws.

CAUTION

If the band is set too far forward in the link, it will buckle slightly when the solenoid plunger is bottomed by hand. If this condition exists the plunger may not bottom when the solenoid is energized. The purpose of the band leaf is to keep the band from splitting when it buckles at the band clamp.

- Step 13:* Interconnect the wires at the knife disconnects and replace the capacitor to the bracket with the two screws removed in Step 5.
- Step 14:* Hook the brake spring to the brake lever. Step 4.
- Step 15:* Replace the motor assembly tightening the four screws that were removed in Step 1.

Packing Precautions for Motors

In packing motors for return to the factory, take particular care to prevent the bending of their shafts in transit.

NOTE

Whenever the remote control unit is not connected, the dummy plug (A-567), supplied with the equipment, must be plugged into J802S.

REMOTE CONTROL

The operation of the tape transport mechanism can be controlled at a location removed from the equipment through the use of a remote control unit. To install the unit, wire it as shown, and plug it into the remote control

connector on the tape transport.

Ampex Corporation does not include remote control as an accessory unit but this manual contains a suggested wiring schematic for customers convenience.

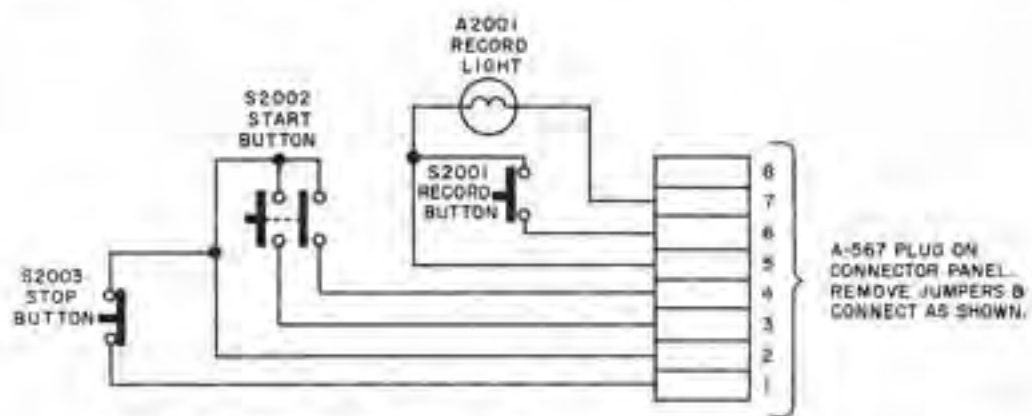

- A2001 120 VOLT, 6 WATT LAMP
- S2001 SNAP ACTION PUSH BUTTON SWITCH, NORMALLY OPEN, 1 AMP 115V.
- S2002 DOUBLE MAKE SNAP ACTION PUSH BUTTON SWITCH, NORMALLY OPEN, 1 AMP 115V.
- S2003 SNAP ACTION PUSH BUTTON SWITCH, NORMALLY CLOSED, 1 AMP 115V.

**IDENTIFICATIONS AND CATALOG NUMBERS
OF VARIOUS TAPE TRANSPORT MECHANISMS**

<i>Tape Transport Ass'y.</i>	<i>Inches per Sec. (ips)</i>	<i>Cycle</i>	<i>Tape Width</i>	<i>Pilot Light</i>
D-7784-01	3¾-7½	60	¼ inch	110 VAC
D-7784-02	7½-15	60	¼ inch	6.3 VAC
D-7784-03	7½-15	50	¼ inch	6.3 VAC
D-7784-04	15-30-60	60	¼ inch	6.3 VAC
D-7784-05	15-30-60	50	¼ inch	6.3 VAC
D-7784-06	15-30-60	60	½ inch	6.3 VAC
D-7784-07	15-30-60	50	½ inch	6.3 VAC
D-7784-08	15-30-60	60	1 inch	6.3 VAC
D-7784-09	15-30-60	50	1 inch	6.3 VAC
D-7784-10	7½-15-30	60	¼ inch	6.3 VAC
D-7784-11	7½-15-30	50	¼ inch	6.3 VAC
D-7784-12	7½-15	60	¼ inch	110 VAC
D-7784-13	7½-15	50	¼ inch	110 VAC
D-7784-14	7½-15	60	½ inch	110 VAC
D-7784-15	7½-15	50	½ inch	110 VAC
D-7784-16	7½-15	60	1 inch	110 VAC
D-7784-17	7½-15	50	1 inch	110 VAC

PARTS LIST TAPE TRANSPORT

PART DESCRIPTION MECHANICAL PARTS AND ASSEMBLIES	AMPEX PART NUMBER		
	1/4-inch	1/2-inch	1-inch
CAPSTAN ASSEMBLY: 15-30-60 ips	7518-01	7518-01	7518-02
CAPSTAN ASSEMBLY: 7-1/2-15 ips	7518-03	7518-03	7518-03
CAPSTAN ASSEMBLY: 3-3/4-7-1/2 ips	7518-04	7518-04	7518-04
Capstan Dust Cap. 7-1/2-15-30 ips	2326-00	2326-00	2326-00
and 15-30-60 ips	2326-00	2326-00	2326-00
Capstan Dust Cap. 3-3/4-7-1/2 ips	2326-03	2326-03	2326-03
and 7-1/2-15 ips	2326-03	2326-03	2326-03
Capstan Felt Washer - - Dust Seal	494-00	494-00	494-00
Capstan Tri-Arc Retainer	430-050	430-050	430-050
CAPSTAN IDLER ASSEMBLY: (All except 3-3/4-7-1/2 ips)	30945-01	30945-03	30945-04
CAPSTAN IDLER ASSEMBLY: 3-3/4-7-1/2 ips	2384-00	-----	-----
Capstan Idler Arm	372-01	372-01	372-01
Capstan Idler Arm Bearing	374-00	374-00	374-00
Capstan Solenoid	670-00	670-00	670-00
Capstan Idler Return Spring	400-00	400-00	400-00
Capstan Idler Adjusting Spring	676-00	676-00	676-00

PARTS LIST TAPE TRANSPORT

DRIVE MOTOR ASSEMBLY: (60 cycles--Com- plete with motor and pulley, 3-3/4--7-1/2 ips, 7-1/2--15--30 ips, 7-1/2--15 ips	1030-01	1030-01	1030-01
For 60 cycles, 15--30--60 ips	1030-02	1030-02	1030-02
For 50 cycles, 7-1/2--15 ips or 7-1/2--15--30 ips	1030-03	1030-03	1030-03
For 50 cycles, 15--30--60 ips	1030-04	1030-04	1030-04
Drive Motor Return Spring (Console and portable)	19994-01	19994-01	19994-01
Drive Motor Return Spring (Rack)	19995-01	19995-01	19995-01
Drive Motor Mounting Hinge	7815-00	7815-00	7815-00
Drive Motor Shield (Bodine Motors only)	1905-00	1905-00	1905-00
Drive Motor Solenoid	670-00	670-00	670-00
Felt Washer (Solenoid Assembly)	503-015	503-015	503-015
Drive Motor Pressure Adjusting Spring	389-00	389-00	389-00

TAPE SPEED SWITCH ASSEMBLY (Includes S501, S502 and S503)	364-00	364-00	364-00
TAKEUP ASSEMBLY: Complete	5704-04	5704-02	5704-03
BRAKE ASSEMBLY	17327-01	17327-03	17327-05
REWIND ASSEMBLY: Complete	5705-04	5705-02	5705-03
BRAKE ASSEMBLY	17327-02	17327-04	17327-06

PARTS COMMON TO TAKEUP AND REWIND ASSEMBLIES

MOTOR ASSEMBLY (Motor, Flange, Brakedrum and Turntable)	6768-00	6768-00	6768-00
BRAKE BAND ASSEMBLY	17612-01	17612-01	17612-01
Brake Band Leaf	61460-01	61460-01	61460-01
Brake Solenoid	337-00	337-00	337-00
Brake Adjusting Spring	322-00	322-00	322-00
Compression Spring	17323-00	17323-00	17323-00
Turntable	61462-01	61462-01	61462-01
	1/4-inch	1/2-inch	1-inch
Housing, Brake	17614-01	17614-01	17614-01
Eye Bolt	396-06	396-06	396-06
Crosshead	17324-01	17324-01	17324-01
Anchor	17325-01	17325-01	17325-01
Spacer	17322-01	17322-01	17322-01
Roll Pin - 1/8 inch x 3/4 inch	406-031	406-031	406-031
Screw, Socket head cap stl. cad. pl.	470-008	470-008	470-008
Brake Band Link	330-00	330-00	330-00
Brake Band Clamp	331-00	331-00	331-00
Brake Lever	332-00	332-00	332-00
Drivelock Pin - 1/8 inch x 1/2 inch	403-008	403-008	403-008
Cotter Pin - 1/16 inch x 1/2 inch	401-005	401-005	401-005
Clevis Pin - 1/8 inch x 9/32 inch	400-002	400-002	400-002
CONNECTOR: J601P, 8 contact, Jones	145-013	145-013	145-013
ROTARY TAPE GUIDE	----	6050-00	6050-01
REEL GUARD (10 1/2 inches)	342-00	342-00	342-00
REEL GUARD (14 inches)	5708-00	5708-00	5708-00

PARTS LIST TAPE TRANSPORT

TAKEUP TENSION ARM ASSEMBLY	425-00	425-00	425-00
Tape Guide	675-00	675-00	675-00
Tape Guide Hook	355-00	355-00	355-00
Takeup Tension Spring	30946-01	30946-01	30946-02
REEL IDLER ASSEMBLY: (All except $3\frac{3}{4}$ - $7\frac{1}{2}$ ips)	4459-00	4459-08	4459-06
REEL IDLER ASSEMBLY: ($3\frac{3}{4}$ - $7\frac{1}{2}$ ips)	4459-03	----	----
REEL IDLER BASE ASSEMBLY	3084C-01	30840-02	30840-02
REEL IDLER PULLEY (All except $3\frac{3}{4}$ - $7\frac{1}{2}$ ips)	5893-00	5893-00	5893-02
REEL IDLER PULLEY ($3\frac{3}{4}$ - $7\frac{1}{2}$ ips) Tape Guide	5893-01 257-00	---- 257-01	---- 1747-00
GUARD, Record Pushbutton	463-00	463-00	463-00
GUARDS, Start and Stop Pushbutton	361-00	361-00	361-00
KNOB, Speed Change	230-010	230-010	230-010
KNOB, Mode Selector	230-002	230-002	230-002
FUSE HOLDER	085-001	085-001	085-001
PILOT LAMP BASE, amber (Single track Model 300)	132-005	132-005	132-005
PILOT LAMP BASE, red	132-006	132-006	132-006
PILOT LAMP BASE, amber (Multi- channel Model 300)	132-011	132-011	132-011
Electronic Parts Common to All Tape Transports Except as Noted.			
A801	LAMP, incandescent: 6.3 volts, .15 ampere, miniature base; General Electric Part Number 47 Used with Single Channel Electronics		060-001
A801	LAMP: 120 volts, 6 watts, candelabra screw base; General Electric Part No. 6T4 1/2/1 Used with Multichannel Electronics		060-006
A802	Same as A801 (060-006)		
C501	CAPACITOR, Drive Motor 5 mfd. 330 V ac		7464-00
	CAPACITOR, Drive Motor: 6 mfd; 330 vacw; 10%: Cornell Dubilier Part No. : MKK3060C		035-245
C601	CAPACITOR, Rewind Motor (60 cps) 3.75 mfd; 330 vacw 10%: General Electric Part No: 21F525		
	CAPACITOR, Rewind Motor (50 cps only) 4.00 mfd; 330 vacw 10%: General Electric Part No: 21F526		035-116
C701	CAPACITOR, Takeup Motor (60 cps) 3.75 mfd; 330 vacw; 10%: General Electric Part No. 21F525		035-111
C801	CAPACITOR, fixed: paper tubular; .01 uf -10 +20%, 600 vdcw; Sangamo Part No. 330601		035-074
C802	Same as C801		
C803	Same as C801		
C804	Same as C801		
C805	CAPACITOR, Fixed: electrolytic, 80 uf, 150 vdcw; Cornell Dubilier Part No. BRM-8015		031-016
C806	Same as C805		
C807	Same as C801		
C808	Same as C801		
C809	Same as C801		
F801	See Fuse Chart Section	Page 5-7	
F802	See Fuse Chart Section	Page 5-7	
F803	See Fuse Chart Section	Page 5-7	

PARTS LIST TAPE TRANSPORT

J601P	See Rewind Assembly 5705	
J701P	See Takeup Assembly 5704	
J801P	CONNECTOR, receptacle: male, 2 contacts, 250 volts, 10 amperes; Hubbel Part No. 4897 <u>Used with 1/4-inch Tape Transports</u>	147-010
J801P	CONNECTOR, receptacle: male, 2 contacts, polarized, 250 volts, 20 amperes; Hubbel Part No. 9105	147-017
J802S	CONNECTOR, receptacle: female, 12 contacts, 730 volts rms, 10 amperes; Jones Part No. S-312-AB	146-009
J804S	CONNECTOR, receptacle: female, 8 contacts, 730 volts rms, 10 amperes; Jones Part No. S-308-AB	146-003
J805S	Same as J804S	
J806S	CONNECTOR, receptacle: female, 2 contacts, 250 volts, 10 amperes; P and S Despard Part No. 1320 and 1354	146-014
J807S	CONNECTOR, receptacle: female, 30 contacts, 730 volts rms, 10 amperes; Jones Part No. S-330-DB	144-017
J808S	Same as J807S	
K801	RELAY, PLAY: 3PDT, 115 volt dc coil std. 10 ampere contact; Philtrol Part No. 33QA	020-000
K802	Same as K801	
K803	Same as K801	
R801	RESISTOR, adjustable: wirewound, 150 ohm \pm 5%, 50 watts; Tru-Ohm Part No. AR-50 type 0566	040-011
R802	RESISTOR, adjustable: wirewound, 500 ohm \pm 5%, 50 watts; Tru-Ohm Part No. AR-50 type 0569	040-014
R803	Same as R801	
R804	RESISTOR, fixed: wirewound, 10 ohm \pm 10%, 5 watts; Tru-Ohm Part No. FRL-5	043-156
S501	SWITCH, safety: SPST, normally closed; Unimax Part No. 2HBT-215-1W	120-001
S502	SWITCH, speed, rotary: Dual DPDT; Arrow H and H Part No. 21490-CA	122-014
S503	Same as S502: (SPEED)	
S801	SWITCH, toggle, ON-OFF: DPST Carling Part No. 2BK62-73	120-003
S802	SWITCH, rotary: 3 pole, 3 position; Centralab Part No. CRL-PA-230-028	122-010
S803	PUSHBUTTON: stop: SPST, normally closed, 1 pole; Arrow H and H Part No. 3391 BSA	120-014
S804	PUSHBUTTON: record: SPST, normally open, 1 pole; Arrow H and H Part No. 3391 EPA	120-013
S805	PUSHBUTTON, PLAY 2 pole, normally open; Arrow H and H Part No. 80913-0	120-025
S806	SWITCH, toggle, FAST START (15-30-60 ips models only); 2 pole, normally open, 1 pole, 2 throw; Arrow H and H Part No. 81021-81021AV or Carling: 2BB62-73	120-011
SR801	RECTIFIER, selenium: single phase, half wave; General Electric Part No. 6RS5CHB21	582-001

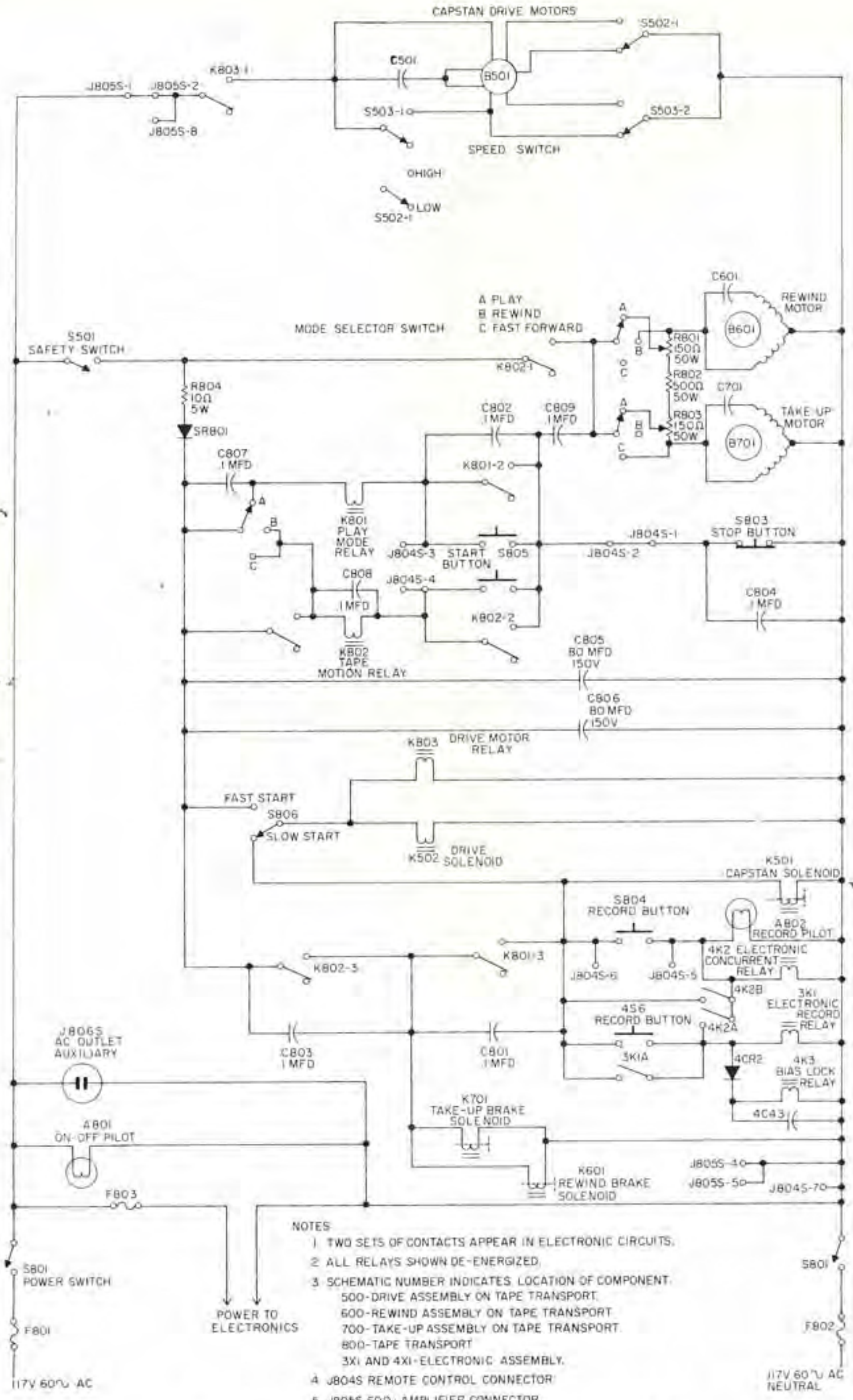

NOTES

- 1 TWO SETS OF CONTACTS APPEAR IN ELECTRONIC CIRCUITS.
- 2 ALL RELAYS SHOWN DE-ENERGIZED.
- 3 SCHEMATIC NUMBER INDICATES LOCATION OF COMPONENT.
 500-DRIVE ASSEMBLY ON TAPE TRANSPORT.
 600-REWIND ASSEMBLY ON TAPE TRANSPORT.
 700-TAKE-UP ASSEMBLY ON TAPE TRANSPORT.
 800-TAPE TRANSPORT
 3X1 AND 4X1-ELECTRONIC ASSEMBLY.
- 4 J8045 REMOTE CONTROL CONNECTOR
- 5 J8055 60Hz AMPLIFIER CONNECTOR.

**SIMPLIFIED CONTROL CIRCUIT SCHEMATIC
MODEL 300 TAPE TRANSPORT**

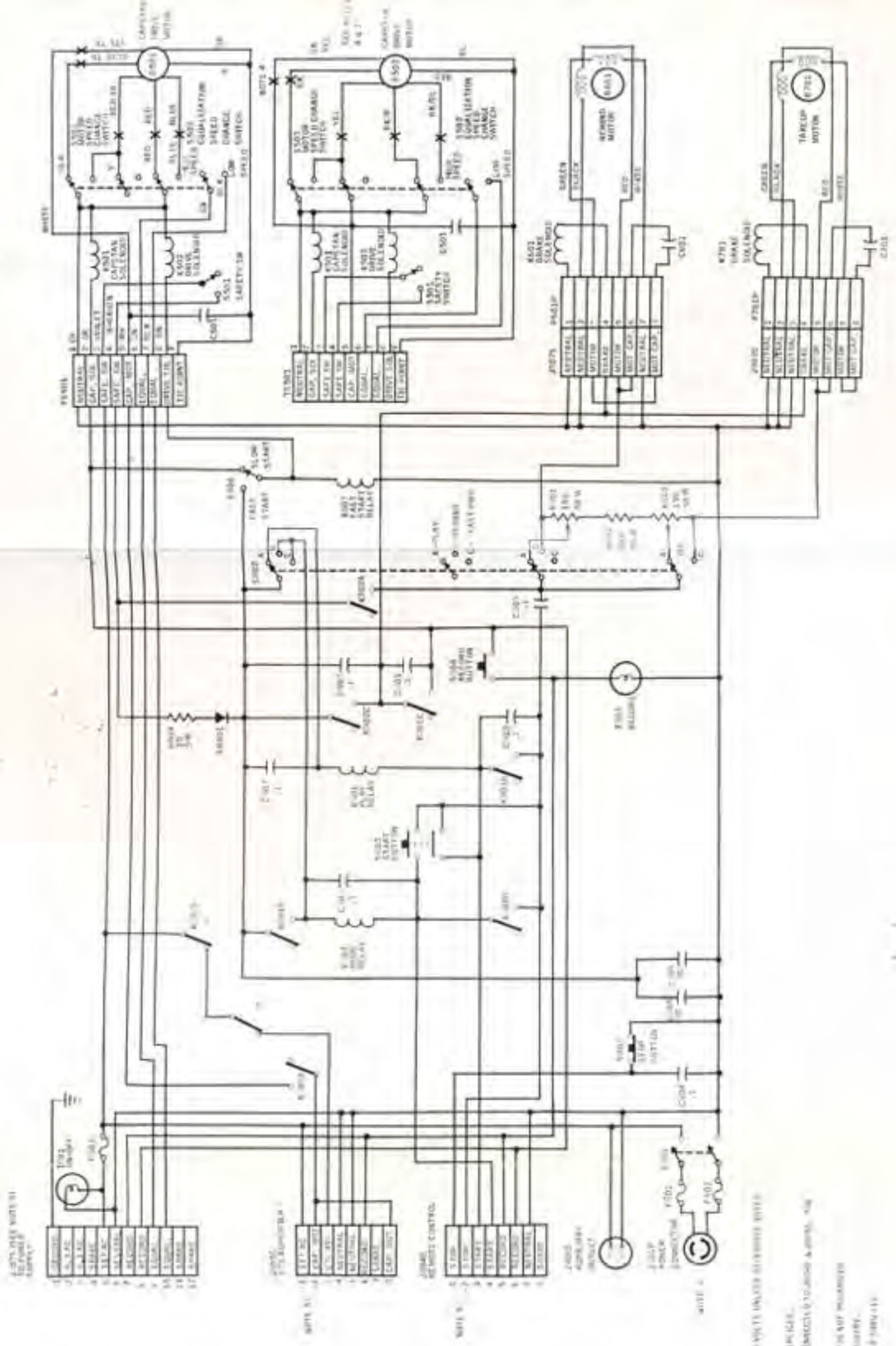

- NOTE 1: ALL RELAYS ARE IN SERIES.
- NOTE 2: ALL OPERATIONS IN PARALLEL.
- NOTE 3: ALL RELAYS SHOWN IN PARALLEL.
- NOTE 4: ALL RELAYS SHOWN IN PARALLEL.
- NOTE 5: ALL RELAYS SHOWN IN PARALLEL.
- NOTE 6: ALL RELAYS SHOWN IN PARALLEL.
- NOTE 7: ALL RELAYS SHOWN IN PARALLEL.
- NOTE 8: ALL RELAYS SHOWN IN PARALLEL.
- NOTE 9: ALL RELAYS SHOWN IN PARALLEL.
- NOTE 10: ALL RELAYS SHOWN IN PARALLEL.

THE AMPEX MAGNETIC HEAD

The head assembly of an Ampex magnetic tape recorder is the heart of the equipment. The technical and detailed know-how required for the fabrication of these head assemblies has made Ampex the foremost manufacturer of magnetic recording equipment in the world today.

In theory, a tape recorder head assembly is a simple device. In practice however, building a head assembly is a complicated task requiring extremely precise manufacturing techniques. There are three head stacks in an assembly—erase, record and playback. In recording, the erase head eliminates any previous recording from the tape. The record head puts a new signal on the tape by magnetizing the iron oxide particles in the coating on the tape. In playback, the magnetic flux in the *moving* tape induces a voltage in the playback head.

The design and construction of these heads is extremely critical. Their surfaces are lapped to finishes so smooth that variations are measured in wave lengths of light. In typical playback heads the gap is .00025 inch, which give







an indication of the precision required in building the heads.

Each of these heads is designed for a specific function with *no compromise* in the overall head assembly. Professional use demands top performance and there is no room for design compromise.

The superb design, engineering and manufacturing care built into Ampex head assemblies assures dependable long life and economical operation at the lowest cost per operating hours.

A portion of the section following will describe briefly by photography the different types of heads used in Ampex Multichannel equipment and a few significant features of development and alignment.

Head assemblies of the Multichannel equipment may be ordered through Ampex Corporation by including information relating to equipment type, equipment serial number, Ampex catalog number and the description of the part.

MODEL	ERASE HEAD	HEAD CONFIGURATION	AMPEX CATALOG NUMBER
300-2 STEREO	FULL TRACK		30028-01
	2-TRACK		30028-02
300-2M 2-TRACK MASTER STEREO	NO ERASE		80000-02
300-3 3-TRACK AND	NO ERASE		30471-01
3-TRACK SEL-SYNC	FULL TRACK 3-TRACK		30471-03 30471-04
300-4 4-TRACK AND	NO ERASE		(OBTAINED ONLY THROUGH AMPEX CONTRACT ENGINEERING)
4-TRACK SEL-SYNC	FULL TRACK 4-TRACK		

NOTE:

ERASE, RECORD AND PLAYBACK ALL UTILIZE THE SAME CONFIGURATION

STANDARD MULTICHANNEL HEAD CONFIGURATION

Head Assembly

The head assembly is housed in a die cast housing and contains three heads used in the operating process. The heads are respectively erase, record and playback as viewed from left to right when facing the machine. The gate on the assembly holds the playback and record shield covers and the tape-lifting fingers. The function of the tape lifting fingers is to remove the tape from the heads when the gate is open during the REWIND and FAST FORWARD operation. The tape may leave a deposit on the heads if allowed to contact them at high speeds.

Such a deposit will seriously impair the performance of the machine and should be guarded against by always opening the gate in the FAST FORWARD and REWIND modes. If a deposit is left, it may be removed by xylene on a soft rag. Never use metal of any kind to touch the head surfaces. The gates should never be allowed to spring shut, but should be closed gently.

Dual Track Head Assemblies

The dual track head assembly is constructed with full track erase or two track erase opera-

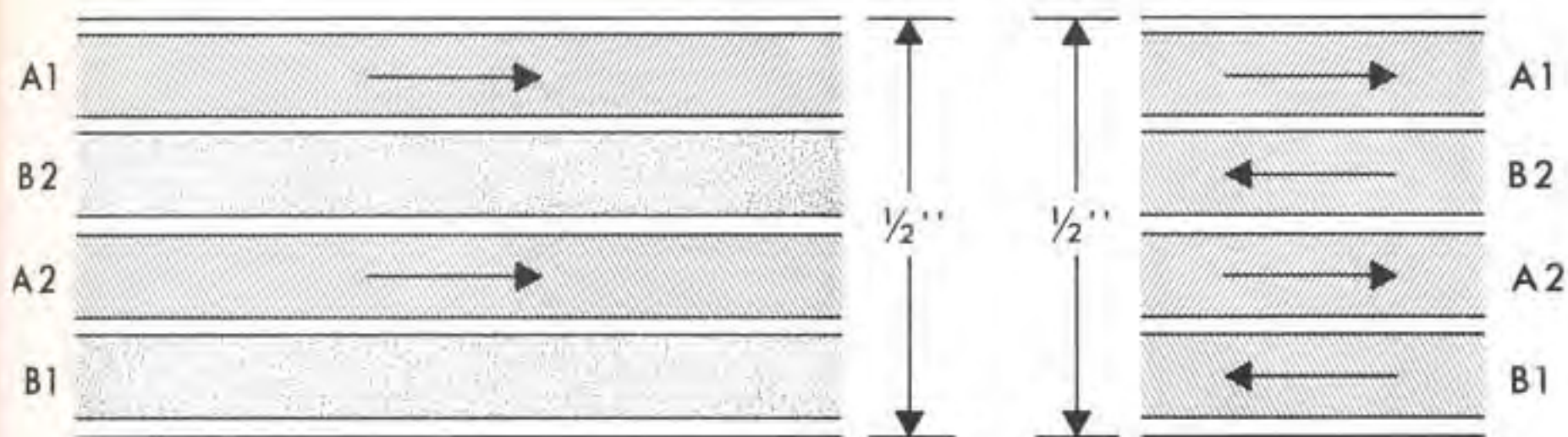

TRACK CONFIGURATION MODEL 300-2M

tion utilizing 1/4-inch magnetic tape. (See chart for information on head configuration and Ampex Catalog Numbers.)

A special designed head configuration in the 300-2Ms dual track, no erase and utilizing 1/2-inch magnetic tape is shown in the chart in this

section of the manual. The purpose of this special head assembly is to record special 1/2-inch wide master tapes on which are recorded two dual track stereophonic programs appearing on opposite directions on the tape. (See chart for head configuration and Ampex Catalog Numbers.)



THREE TRACK HEAD ASSEMBLY



FOUR TRACK HEAD ASSEMBLY

Multichannel Head Assemblies

The three track head assembly (for Series 300-3 equipment) can be obtained containing no erase, a full track erase or a 3 track erase head, using 1/2-inch magnetic tape. This three track configuration permits recording of all three tracks separately or simultaneously. When using the Sel-Sync accessory unit with this Series 300-3 equipment the same head assembly is utilized.

The four track head assembly (for Series 300-4 equipment) can be obtained only by special order through Ampex Contract Engineering. Using 1/2-inch magnetic tape, this head assembly may be purchased with no erase, a four track erase or a full track erase head depending on the customer demands. When using the Sel-Sync accessory unit with this Series 300-4 equipment the same head assembly is utilized.

PART DESCRIPTION

INDIVIDUAL REPLACEABLE HEAD PARTS

*AMPEX
PART NUMBER*

Gate Spring, two required	438-01
Gate, Pin, two required	403-006
Glass Rod, Tape Guide 13/16 inches long, two required	457-00
Glass Rod, Tape Guide, 1/2 inch long, four required	1372-00
Gate Assembly (1/4-inch tape)	479-00
Gate Assembly (1/2-inch tape)	5635-00
Housing (1/4-inch tape)	433-01
Housing (1/2-inch tape)	5639-00



HEAD AZIMUTH ADJUSTMENT

ELECTRONIC ASSEMBLY

NOTE

This manual is primarily intended for use with Catalog No. 30960 electronic assemblies. Schematic and parts lists for earlier models using Catalog No. 30750 electronic assemblies are included.

GENERAL

The electronic assembly consists of a single chassis on which are mounted three sub-assemblies of etched board construction—the record amplifier with bias and erase oscillator, the re-

produce amplifier, and the power supply. Each subassembly is an etched board entirely which can be taken from the main assembly by disconnecting the edge-on harness connectors and removing four mounting nuts.

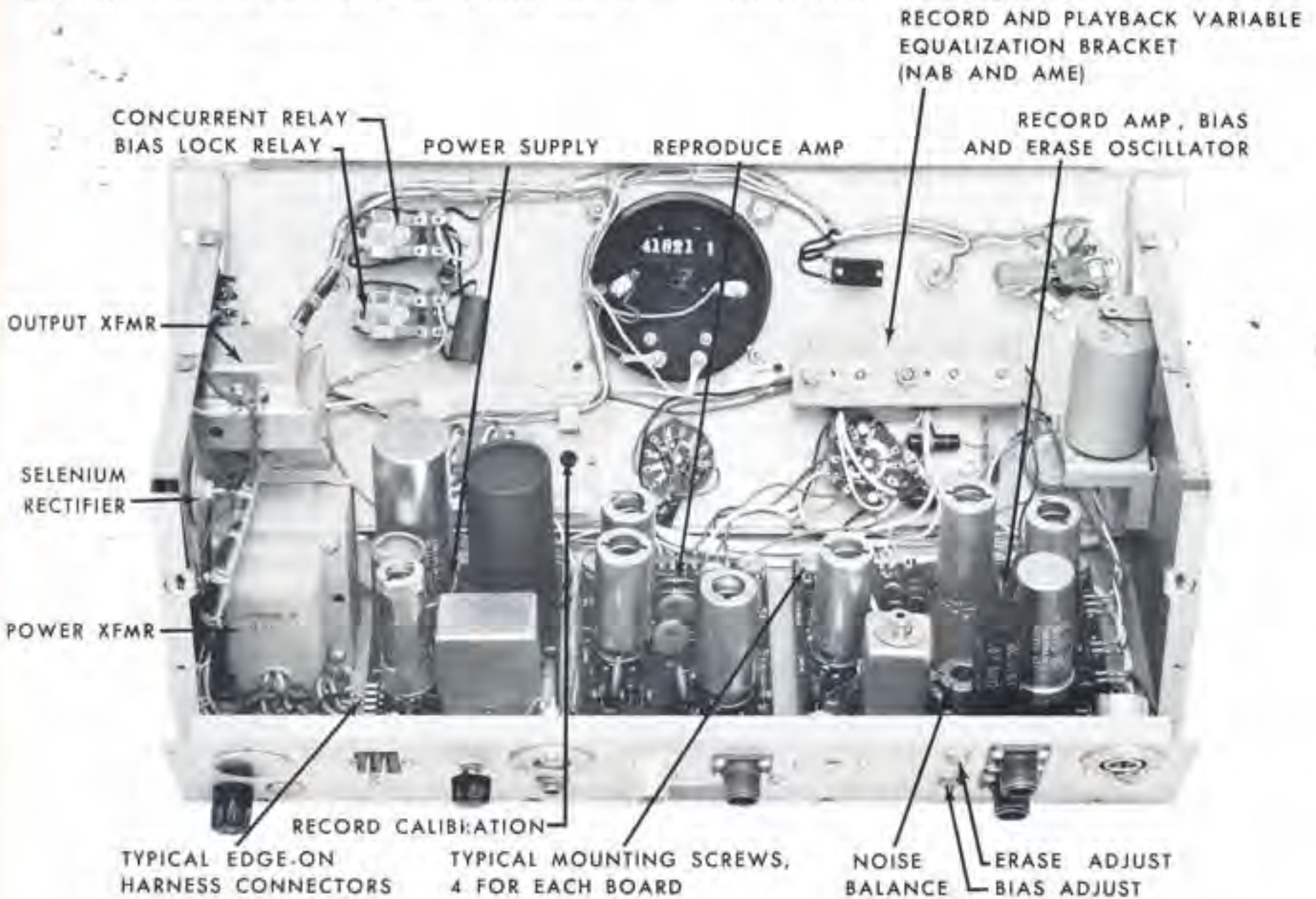

LOCATION OF ELECTRONIC SUBASSEMBLIES



AMPLIFIER CHASSIS, FRONT PANEL

On the face panel facilities are available for setting record and reproduce levels, selecting high or low speed equalization circuitry, making input transfers for microphone, balanced bridge or unbalanced inputs, and switching meter and output circuitry. Visual monitoring of reproduce record, bias and erase levels can be done at the vu meter on the face panel. Two phone jacks for aural monitoring are provided, one on the face panel and another on the back of the electronic chassis. Power on-off is controlled at the front of the assembly. A control for the record function, signified by an accompanying indicator light, completes the front panel arrangement.

Accessible on the back of the electronic assembly chassis are all connecting and interconnections provisions for line input, line out-



AMPLIFIER CHASSIS, REAR VIEW

put, connections to the tape transport, head connections and bias coupling. One screw-type fuse post and a line termination selector switch are also provided on the chassis back panel.

RECORD AMPLIFIER

The record section of the electronic assembly is a four stage, high gain, resistance coupled amplifier using transformer input coupling for microphone or balanced bridge, and by-passing the transformer and the first stage when the unbalanced bridge input is selected. Two dual triodes, 1V1 and 1V2 and their related circuitry, form the four stages of amplification.

When the microphone INPUT is selected the signal from 5J1 is impressed across the primary of input transformer 6T1 and delivered through the secondary to the grid of 1V1.

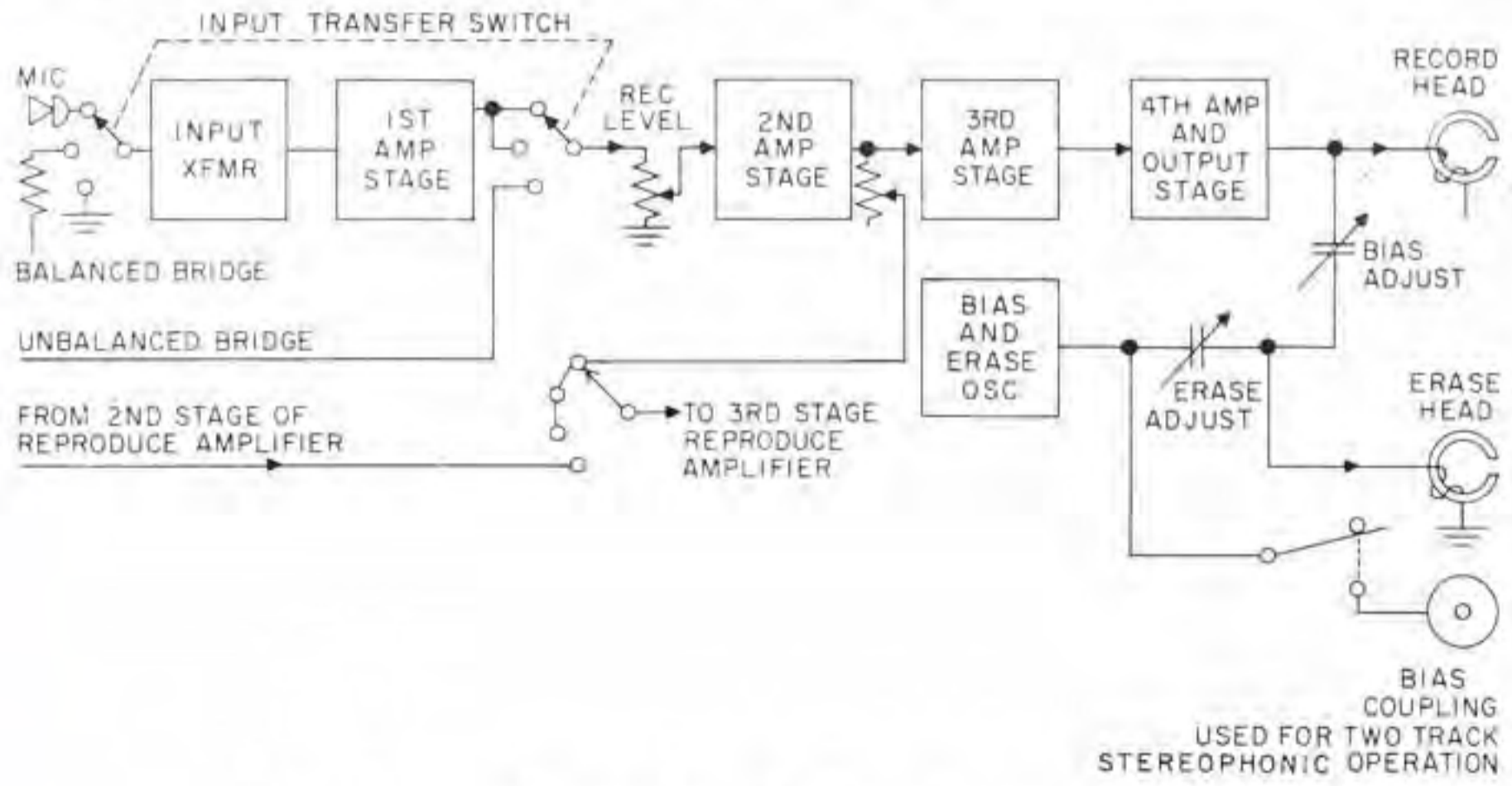

BLOCK DIAGRAM RECORD CIRCUIT

In the balanced bridge arrangement, the signal passes through resistor network 4R1, 4R4 and 4R5 to input transformer 6T1 with resistors 4R2 and 4R3 providing the balance above ground. From the secondary of transformer 6T1 the signal then appears at the grid of 1V1.

Using the unbalanced bridge arrangement, transformer 6T1 and the first stage of 1V1 are by-passed, the signal appearing at the grid of the second stage through resistor 4R5 and across potentiometer 4R9 with resistor 4R3 and 4R4 completing the circuit to ground.

At the first stage, bias and negative feedback are achieved by means of unbypassed resistor 1R7. When this first stage is used, the amplified signal is coupled through capacitor 1C1 and potentiometer 4R9 and resistor 1R8, in parallel, to the grid of the second stage where further amplification takes place. Potentiometer 4R9 provides a means for setting RECORD LEVEL. Bias and negative feedback in the second stage are attained by unbypassed resistor 1R11. Capacitor 1C2A and resistor 1R13 form a plate decoupling network. Capacitors 1C3 and 1C4 and potentiometer 4R12 (RECORD CALIBRATE) provide record calibration circuitry.

NOTE

When reading meter indications with the METER AND OUTPUT SWITCH in the record position, only the first two stages of the record amplifier and the last three stages of the reproduce amplifier are connected in the circuit, omitting record pre-emphasis and reproduce equalization circuitry so that meter indications will reflect only the flat portions of each amplifier.

The signal now is coupled to the grid of the third stage by capacitor 1C5, bias and negative feedback is provided through unbypassed resistor 1R16. Further amplification takes place in this third stage and pre-emphasis circuitry for HIGH and LOW tape speeds is provided at components 1R17, 4C47, 4C41, 4C42, 4R67 and 4C48 which provide the necessary high frequency rise. At the low end of the frequency spectrum, an effective 3 db gain is furnished by the resistor/capacitor combination 1R18 and 1C8. With 15 inches per second (ips)

AME position, 4C40, provides variation in the pre-emphasis in the 5 to 15 kc region.

In the fourth stage, coupled to the third stage by capacitor 1C9, the signal is applied to the grid of 1V2. Bias and negative feedback is supplied by unbypassed resistor 1R21. The fourth stage is designed to act as a constant current amplifier in order to feed the reactive load presented by the record head. The output of this fourth stage is mixed with the signal from the bias and erase oscillator and delivered to the record head.

Plate voltage for the first three stages is supplied whenever POWER switch 4S5 is in the ON position. For plate voltage supply to the final stage, the equipment must be in the record mode at which time relay contacts 3K1C complete the necessary circuitry.

REPRODUCE AMPLIFIER

The reproduce section of the electronic assembly is a five stage, resistance coupled, audio amplifier. Three dual triodes are used to provide three stages of amplification, phase inversion and a push-pull output amplifier.

Signals on the moving magnetic tape induce voltages in the reproduce head. When high impedance heads are used, this induced voltage appears across resistor 2R25 and then on the grid of 2V3. When low impedance heads are used the signal is first passed through step-up transformer 6T2. Bias on this first stage is derived from the voltage divider network consisting of resistors 2R26 and 2R28 plus tube current through resistor 2R28. Capacitor 3C16a and resistor 3R32 form a plate decoupling network. The amplified output of this first stage is coupled to the second stage grid through capacitor 2C14. Capacitor 3C16b and resistor 3R35 form a plate decoupling network. In the 7½ and 15 NAB position, reproduce equalization is achieved by means of capacitor 2C15 and resistors 2R28, 2R29 and 4R69. 4R69 controls the high frequency shelf. In the 15 (ips) AME position a bridge T filter connected between the 2nd stage and 4R36 provides the additional dip required to produce the curve. A variation for the AME reproduce curve is supplied by 4C44 in the 7 kc and 15 kc region. The variable repro-

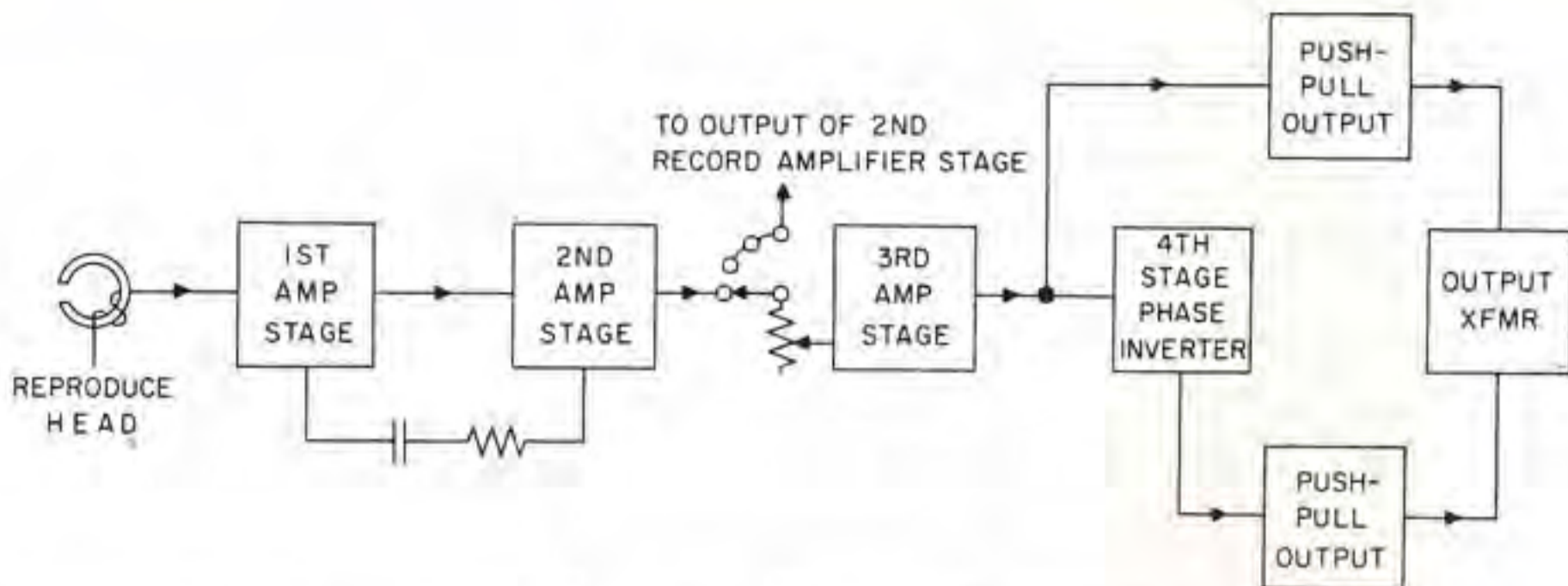

BLOCK DIAGRAM REPRODUCE CIRCUIT

duce equalizers 4C44 and 4R69 are used to compensate for head variations to furnish the flat-

CAUTION

The reproduce variable equalizers (4C44 and 4R69) should not be used to compensate for variable in tape.

test possible response when reproducing a standard tape.

The signal now is delivered to amplifier stage 2V4, the tube receiving the signal through coupling capacitor 2C17, PLAYBACK LEVEL potentiometer 4R36 and switch 4S3a. The output of 2V4a is coupled through 2C19 to one grid of the push-pull output stage, and a portion of this output is coupled through capacitor 2C18 to phase inverter 2V4b. Both signals, now 180 degrees out of phase with each other, are fed through coupling capacitors to the respective grids of push-pull amplifier 2V5 and then to the primary of center tapped output transformer 6T3.

After the signal reaches the secondary of output transformer 6T3, it is delivered to the LINE TERM switch 5S4 for selection of resis-

tor 5R48 to obtain a nominal 600 ohm line output termination when an external load is supplied.

Again, the signal can be monitored at 4J6 PHONES or at the vu meter using the PLAYBACK position of the METER and OUTPUT SWITCH.

Transformer strapping and cabling connections for various outputs are discussed in SECTION 2 INSTALLATION.

BIAS AND ERASE OSCILLATOR

A dual triode tube 1V6, connected as a push-pull oscillator, provides high frequency bias and erase signal. Both halves of the tube are resistance coupled triode amplifiers, the output of each plate coupled to the grid of the other triode section. Any signal on the grid of either tube will be amplified in the plate circuit and coupled to the grid of the other tube. The signal then will appear at the plate of the second tube and be coupled back to the grid of the first tube in phase with the original signal. Frequency of oscillation is approximately 100 kc.

With 117 volts d-c terminating at pin 3 of 5J7, Bias Lock relay (4K3) and RECORD relay (3K1) are energized when RECORD button (4S6) is pressed. Capacitor 4C43 charges and the combination of capacitor 4C43 and rectifier 4CR2 delays the opening of 4K3 until 3K1 opens. Contact set 4K3a connects the bias oscillators of all the electronic assemblies together through resistor 4R70 (220 ohms) for

operation of two or more electronic simultaneously.

The oscillator output is fed through relay contacts 4K3B to variable capacitor 5C33 ERASE ADJUST, where erase current adjustments are made, and then to the ERASE HEAD. From 5C33 it follows another path through variable capacitor 5C13 BIAS ADJUST where bias current adjustments take place. The bias signal is then mixed with the record signal and delivered to the record head.

NOISE BALANCE control, potentiometer 1R63, in the oscillator grid circuits is adjusted to correct for any asymmetry in waveform which would cause random noise during reproduction and distortion while recording.

Plate voltage is supplied through contact K1C only when the equipment is in the record mode.

POWER SUPPLY

Vacuum tube 3V7, connected as a conventional full wave rectifier, supplies plate power for all tubes in the electronic assembly, and it also supplies the record indicator light. Selenium rectifier CR1, connected as a conventional full wave rectifier provides d-c heater voltage for 1V1, 1V2 and 2V3.

The center tap of the 2V3 tube heater provides a ground for the d-c filaments, and this tube must be in its socket for proper operation in any mode. A-c power input is supplied from the tape transport through 5J7 and is controlled by switch 4S5 POWER. The power is fed through fuse 5F1 and impressed across the primary of power transformer 6T4.

There are four secondary windings on the power transformer—three for heater supply and one for high voltage. One heater winding serves rectifier tube 3V7, one center-tapped winding provides 12.6 volt d-c heater voltage after rectification, one winding supplies 12.6 and 6.3 volt a-c voltage, and the other center-tapped winding furnishes high voltage. An rc network consisting of the four section capacitor 3C16 and resistors 3R54, 3R55 and 3R56 provides filtering action. Relay contact 3K1B shorts resistor 3R54 in the record mode to provide a nearly constant B+ supply in any mode of operation.

Through record relay 3K1C, B+ is applied to the bias oscillator and the last stage of the record amplifier. Whenever the PLAY button on the tape transport is pressed, 115 volt d-c is available at pin 3 of 5J7, and when RECORD button 4S6 is pressed, the 115 volt d-c is applied to the record relay coil. As long as 115 volt d-c is available at pin 3 of 5J7, contact 3K1A holds the relay energized. When the STOP button on the tape transport is pressed, the 115 volt d-c no longer reaches pin 3 of 5J7 and relay 3K1 is de-energized and drops out. Relay 4K2 is energized whenever d-c is supplied to pin 5 of 5J7 by pressing RECORD button S804 on the tape transport. Concurrent RECORD RELAY 4K2 in turn energizes 3K1 and 4K3. BIAS LOCK RELAY 4K3 is then held energized through its arm contacts to pin 3 of plug 5J7.

ALIGNMENT AND PERFORMANCE CHECKS

Equipment Required

Ampex Standard Alignment Tape

Speed	Width	Catalog Number Ampex
7½ Inches per Second (NAB)	¼ inch tape	31321-01
15 Inches per Second (NAB)	¼ inch tape	31311-01
15 Inches per Second (AME)	¼ inch tape	31312-01
7½ Inches per Second (NAB)	½ inch tape	31321-05
15 Inches per Second (NAB)	½ inch tape	31311-05
15 Inches per Second (AME)	½ inch tape	31312-05

A-c Vacuum Tube Voltmeter capable of indicating rms voltages of .004 or less.

Audio Oscillator with stable output from 50 cps to 15 kc.

Earphones or Speaker for Monitoring Aurally.

Nutdriver number 8 (¼ inch).

Reel of unrecorded tape.

Long Screwdriver (approximately 7 inch bit).

Small Screwdriver.

Reproduce Alignment

Step 1: Remove the head cover.

Step 2: With the equipment connected as shown and all power switches in the ON position, thread an Ampex standard tape for the appropriate speed along the prescribed path.

CAUTION

The standard alignment tape used in the following procedures may be partially erased if the record and reproduce heads are permanently magnetized. Demagnetize the heads before proceeding. Do not replace the head cover on the head assembly.

- Step 3:* Set the EQUALIZATION switch to the desired speed.
- Step 4:* Place the METER AND OUTPUT switch in the PLAYBACK position.
- Step 5:* Terminate the output in a nominal 600 ohms (LINE TERM switch in the ON position or use a 600 ohm external load).
- Step 6:* Start the standard tape. The 15 inches per second standard tapes have all tones recorded at operating level (level that produces approximately 1% distortion). The 7½ inch per second tapes have all tones recorded 10 db below operating level except for the last reference level which is recorded at operating level. The first tone on all standard tapes is a reference level, 700 cycles for 7½ and 15 inches per second. For 15 inches per second, adjust the playback level control so the VU meter reads zero or a VTVM across the output reads +8 dbm. For 7½ inches per second, adjust the playback level control to a convenient meter reading for checking alignment and response.
- Step 7:* The next tone will be 15,000 cycles for adjusting reproduce head alignment. Take the number 8 nut driver and adjust the left hand stop nut on the reproduce head for maximum output on VU meter or VTVM. If all channels do not peak at the same setting, make a compromise adjustment. If the peak is broad, adjust for minimum output variation.

NOTE

The Model 300-2M uses fixed base heads so azimuth adjustment is not necessary.

NOTE

If the head azimuth is far out of alignment (possible if inexperienced personnel without proper equipment have attempted alignment procedures) minor peaks may be observed on both sides of the maximum. The proper setting is 15 to 20 db higher than these peaks.

- Step 8:* Tones from 15,000 cycles to 50 cycles now will be reproduced from the standard tape. Adjust the appropriate variable equalizer (4R69 for 7½ and 15 NAB) to give the flattest possible high frequency response. For 15 ips AME, using an AME standard tape, adjust 4C44 so the tapes above 5 kc will reproduce as flat as possible. If an AME tape is not available, the 15 ips NAB tape can be used. In this case the response should follow the curve shown in back of Section 7.

CAUTION

The equalizers should not be used to compensate for system deficiencies (dirty leads, bad alignment, etc). In general, the playback equalizer should not be moved more than 2 db from the standard curve.

NOTE

When reproducing Ampex standard alignment tapes on multi-track equipment the bass end of the frequency spectrum will rise in response. The actual amount of rise will vary with the width and location of the track. This phenomena is present because the reproduce head "sees" additional flux on each side of the head at long wavelengths since the standard tapes are recorded across the complete width of the tape. This fringing effect is not present when recording a track the same width as the reproduce head. The electronics should not be readjusted to compensate for this rise.

- Step 9:* *Reproduce level control calibration—*
The next tone to be heard on the 7½

inch per second standard tape is a reference tone at operating level. Adjust the playback level control to obtain a zero reading on the VU meter or a +8 dbm (1.95V) output on a VTVM. On the 15 inch per second standard tape, all tones are at operating level, so this calibration was made in Step 5.

NOTE

Do not change this playback level setting for the remainder of the adjustments.

Reproduce Amplifier Noise Measurement

- Step 1:* After performing the previous alignment checks, stop the tape motion.
- Step 2:* Read the stopped tape noise measurement on the VTVM. Noise should be below the level specified in performance characteristics. Inaudible low frequency bounce can cause the meter to read higher than performance characteristics tolerances. Disregard these momentary readings because they are frequencies far below the operating range.

Record Amplifier Erase Current Adjustment

- Step 1:* After the equipment has been properly installed and connected, and all POWER switches are in the ON position, thread blank tape along the prescribed path.
- Step 2:* Place the INPUT TRANSFER switch in the UNBAL BRIDGE position.
- Step 3:* Set the METER AND OUTPUT switch to the ERASE function.
- Step 4:* Center the noise balance potentiometers. When the user faces the front panel, the slot should parallel the face plate.
- Step 5:* Place one channel at a time in the record mode.
- Step 6:* Using a small screwdriver set the ERASE ADJUST trimmer on the back of the electronic chassis to obtain zero VU meter readings at 117 volt a-c line voltage.

NOTE

When the METER AND OUTPUT switch is in the ERASE position, meter readings must be made with only one amplifier in the record mode because if all amplifiers are recording, false readings will be taken. Erase current will be directly proportional to line voltage and the vu meter readings will reflect any changes from the 117 a-c line voltage.

Record Amplifier Bias Adjustment

NOTE

This adjustment should be made using the brand of tape that normally will be used on the equipment.

- Step 1:* Place the METER AND OUTPUT switch in the PLAYBACK position.
- Step 2:* Place the equipment in the record mode at the 7½ inch per second speed.
- Step 3:* Place the INPUT TRANSFER switch in the UNBALANCED position and connect the audio oscillator into the RECORD LINE INPUT (pins 1 and 3).
- Step 4:* Set the oscillator frequency at 500 cycles per second (cps) and approximately 1 volt for 7½ inches per second (ips).

NOTE

Bias is set at a specific wave length. If it is desired to set bias at 15 inch tape speed, use a frequency of 1000 cps.

- Step 5:* Place the RECORD LEVEL knob at a position that will obtain an on-scale meter reading.
- Step 6:* With a small screwdriver set the BIAS ADJUST trimmer for a maximum reading on the vu meter. An accurate way to set peak bias is to adjust the BIAS control clockwise until the 500 cycle signal drops ½ db below maximum reading. Note the current reading by placing the METER OUTPUT switch in BIAS position. Turn the BIAS control counterclockwise until

the 500 cycle signal drops $\frac{1}{2}$ db and note that current reading. Set the BIAS at the median of these two readings.

Record Level Calibration

NOTE

The reproduce level must be calibrated using standard tape (7½ or 15 ips NAB) before calibrating the record level (see Reproduce Level Control Calibration).

- Step 1: Set the audio oscillator to 250 cps. Leave the METER AND OUTPUT switch in the PLAYBACK position.
- Step 2: Press the RECORD button (S804).
- Step 3: Set the RECORD LEVEL knob to a position that will obtain a zero reading on the vu meter.
- Step 4: Place the METER AND OUTPUT switch in the RECORD LEVEL position.
- Step 5: Using a long shank screw driver (to avoid burns from the electronic tubes), adjust the record calibration potentiometer (4R12) for a zero vu reading.

Record Azimuth Adjustment

NOTE

There is no azimuth adjustment on 300-2M.

- Step 1: Set the oscillator to 15,000 cycles at 15 inches per second or 10,000 at 7½ inches per second (ips).
- Step 2: Place the METER AND OUTPUT switch in the RECORD LEVEL position.
- Step 3: Set the RECORD LEVEL knob to obtain a vu meter reading of approximately -10. Place PLAYBACK LEVEL control at 16 on the dial.
- Step 4: Place the METER AND OUTPUT switch in the PLAYBACK position.
- Step 5: Press the RECORD button (S804).
- Step 6: With the nut driver rotate the adjustment nut on the left side of the record head (as the user faces the front of the equipment) to obtain a maximum VTVM reading. Several peaks will ap-

pear, but the maximum peak is obvious because it is much greater than the minor peaks. If all channels do not peak at the same point make an optimum adjustment.

CAUTION

The right hand nuts are factory set. Do not adjust them.

Overall Frequency Response and Equalizer Adjustment

To avoid tape saturation of the high frequency signals which might be caused by the record pre-emphasis, frequency response at tape speeds of 15 inches per second (ips) tape speed should be made at least 10 db below operating level (-2 dbm); at tape speeds of 3¾ and 7½ ips frequency response should be made at least 20 db below operating level (-12 dbm). The vu meter may be used for checking 15 ips response by turning up the PLAYBACK LEVEL control. However, for checking tape speeds of 7½ and 3¾ inches per second frequency response a vacuum tube volt meter (VTVM) connected across the output will be more accurate, since there is not enough playback gain to make a signal recorded 20 db below operating level read zero on the vu meter.

- Step 1: Place the METER AND OUTPUT switch in the RECORD LEVEL position.
- Step 2: At the desired tape speed, set the oscillator for 250 cycles and adjust RECORD LEVEL control to obtain a vtvm reading of -12 dbm (.195 volts) for tape speeds of 7½ and 3¾ inches per second (ips) and -2 dbm (.62 volts) for tape speed of 15 inches per second.
- Step 3: Place the METER AND OUTPUT switch in the PLAYBACK LEVEL position.
- Step 4: Press the RECORD button (S804).
- Step 5: Make a response check by sweeping the oscillator through the frequency range. Because there are variations among tapes of different manufacturers, the appropriate record equalizers may be adjusted to give the flattest possible response with the tape being used. The BIAS control may

also be used to vary the high frequency response, however, it should be remembered that the bias has much more effect at low speeds ($3\frac{3}{4}$ and $7\frac{1}{2}$ inches per second) than at the higher speeds. If bias is used to smooth out high frequency response at 15 inches per second, it may easily throw $7\frac{1}{2}$ ips out of specification.

Record Noise Balance Adjustment

- Step 1:** Re-establish the reproduce (PLAYBACK LEVEL) volume control setting as described earlier in this section under *Reproduce Level Control Calibration*.
- Step 2:** Position the RECORD LEVEL knob at the zero calibration point.
- Step 3:** Disconnect any input. Place one channel at a time in the RECORD mode. DO NOT attempt this adjustment with more than one channel in RECORD.
- Step 4:** Plug a set of earphones into the monitor jack and listen for the minimum noise location while adjusting the noise balance control.

NOTE

If the slot of the noise balance adjustment is more than 45 degrees from a line parallel to the plane of the face plate, troubleshooting is indicated. If the noise tends to null at either adjustment extreme, it indicates excessive leakage in capacitor 1C10, trouble in the oscillator circuitry or magnetized heads.

Record Noise Measurement

To translate vtvm readings into specific signal-to-noise ratios when the vu meter is so calibrated that zero vu corresponds to +8 dbm output, add 6 db to obtain the output value from the 3% distortion level, arriving at a total of 14 dbm. Having made this computation, bear in mind that, although the noise reading taken on the vtvm is dbm, the measurement is a *ratio* which must include the 14 dbm computed to arrive at the 3% distortion level. Therefore, the vtvm reading must be converted to the signal-to-noise *ratio*.

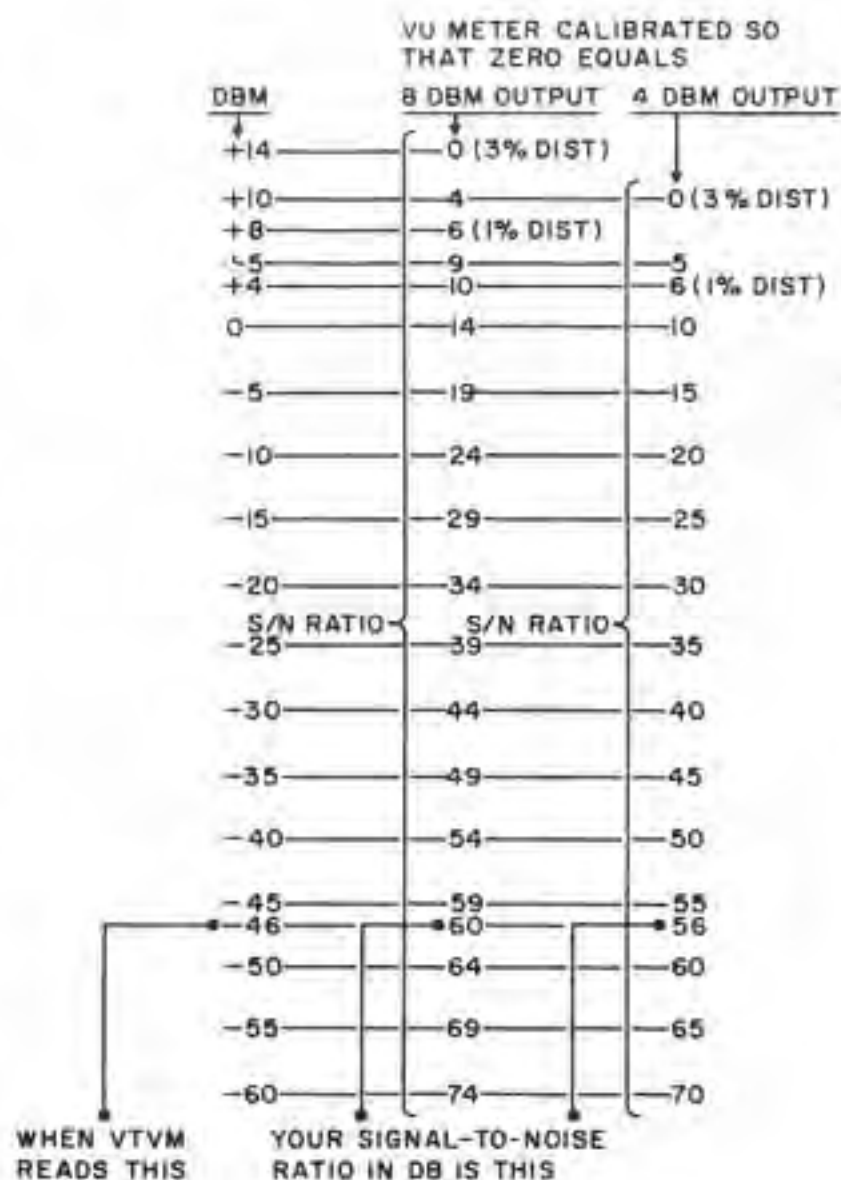

SIGNAL-TO-NOISE RATIO COMPUTATIONS

Example: +14 (dbm, includes +8 dbm output and 6 db up to 3% distortion level)
 -46 (dbm, vtvm reading)
 60 db signal-to-noise ratio (although the signs are different, the values are added to get a ratio)

Any reading below 60 db meets performance characteristics specifications and satisfies the signal-to-noise ratio definition.

When the vu meter is so calibrated that zero vu corresponds to +4 dbm output add 6 db to obtain the output value from the 3% distortion level arriving at a total of 10 dbm.

Example: +10 (dbm, 4+6)
 -46 (dbm, vtvm reading)
 56 (db, signal-to-noise ratio)

Ampex signal-to-noise ratio specifications on audio instruments define in decibels the ratio existing between the level of a steady 1000 cycle

tone, recorded at a level at which distortion produced by the approach of tape saturation equals 3% total rms, and that level of total rms noise, in the band from 30 to 15,000 cycles, which exists in reproduction under the same gain conditions.

Ampex audio instruments normally are calibrated so that the vu meter reads zero level when reproducing a steady 1000 cycle tone the level of which produces 1% total rms distortion, due to the approach of tape saturation.

A recorded 1000 cycle tone at the 3% distortion level will be 6 db higher in level than a recorded 1000 cycle tape at the 1% level.

- Step 1:* Place the METER AND OUTPUT switch in the RECORD LEVEL position.
- Step 2:* Set the oscillator to 400 cps.
- Step 3:* Adjust the RECORD LEVEL control to obtain a vtvm reading 6 db above operating level (+14 dbm for equipment with 8 dbm output).
- Step 4:* Record the 400 cps on a section of tape, noting where the recording begins for later reference.
- Step 5:* Disconnect the oscillator.
- Step 6:* Set the RECORD LEVEL control to zero.
- Step 7:* Rewind to the beginning of the 400 cps recording.
- Step 8:* Erase the tape by recording with zero signal.
- Step 9:* Rewind again to the beginning of the recording.
- Step 10:* Read the vtvm and check the reading against the table.

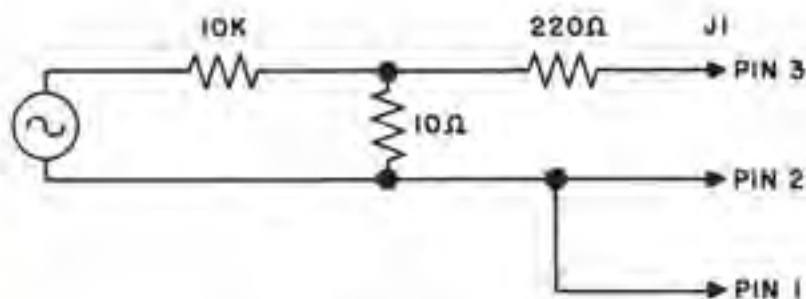

MICROPHONE RESPONSE SET-UP

Microphone Response

Connect an audio oscillator as shown in the

illustration and make the response check by sweeping the oscillator through the frequency range to be checked.

MAINTENANCE AND TROUBLESHOOTING

General Maintenance Information

Faithful adherence to the recommended ROUTINE MAINTENANCE found in SECTION 5 TAPE TRANSPORT MECHANISM and careful performance checks will insure excellent equipment operation. When the cleaning, lubricating and demagnetizing procedures are followed as prescribed and the system is set up according to the instructions in this manual, equipment performance should meet the high Ampex standards.

Neglect of maintenance procedures, such as failure to clean the capstan, the head faces and the tape guides daily can cause deficiencies that are reflected in the amplifiers. For instance, poor tape-to-head contact, due to tape oxide accumulations, will diminish high end frequency response.

Rewinding or moving the tape in the fast forward mode with the head assembly gate closed eventually will wear grooves in the heads, causing a similar result.

Improper head azimuth adjustment will also affect high frequency response.

When the user suspects amplifier faults, the above information should be considered, and, if satisfied that the cause is in the amplifier, he then can begin troubleshooting.

Progressive Maintenance of the Amplifiers

Depending on equipment, check B+ voltage at junction of 3R55 and 3R58 and make a check of tube emission. Make sure tubes are returned to same socket. Check DC filament voltage to note aging of 6CB1. 3R60 may be reduced in value or shorted out as rectifier ages. Clean the relay contacts by inserting a piece of high quality bond paper between contacts and pulling it back and forth several times.

Corrective Maintenance

The first step in any corrective maintenance procedure is localizing the faulty circuit. If a tape recorded on the equipment itself does not reproduce correctly, the trouble can be in

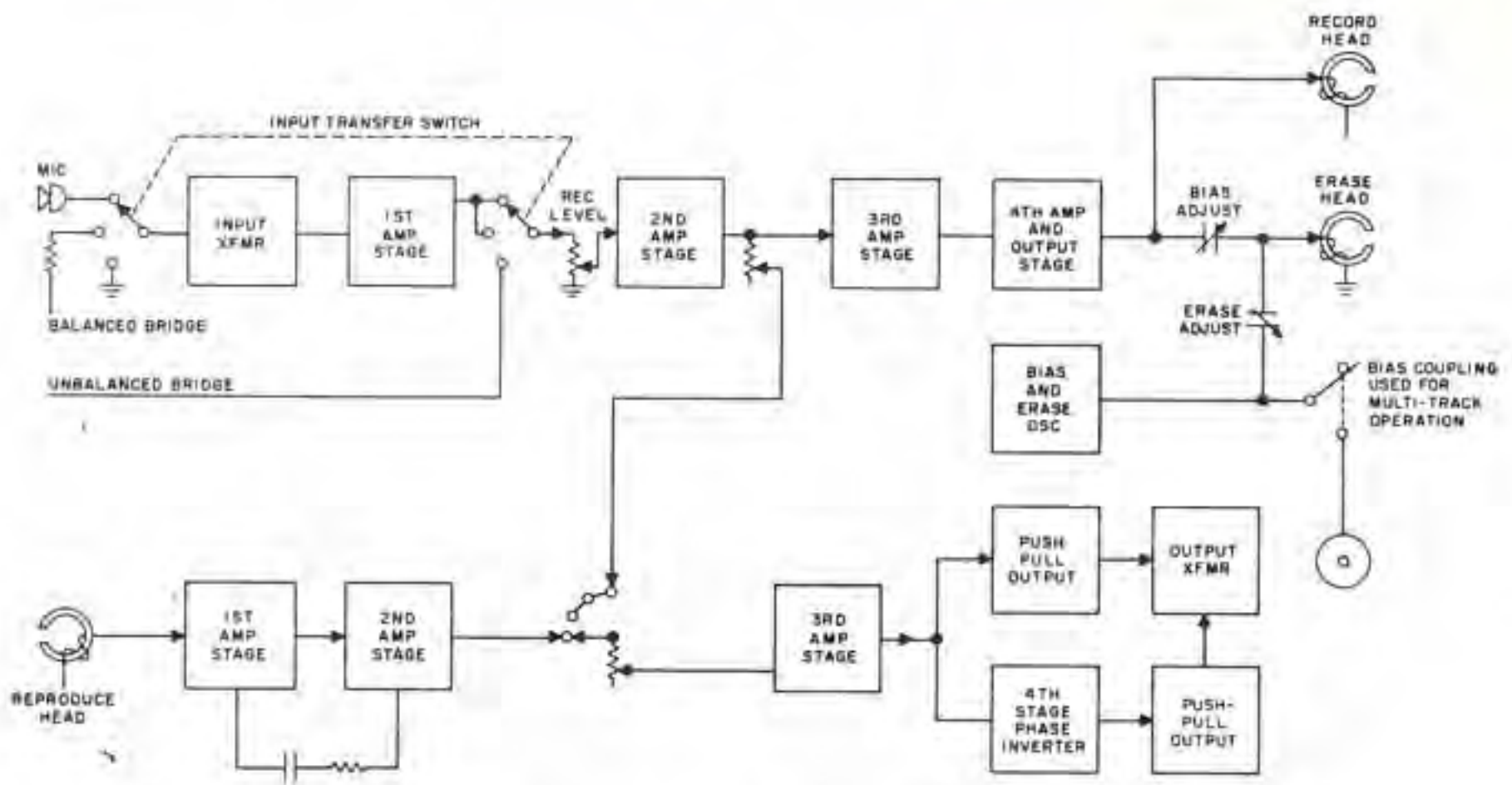

SYSTEM BLOCK DIAGRAM

either the record or the reproduce circuit. In this case, the faulty circuit can be identified by reproducing a standard alignment tape or a commercially recorded tape; if, while reproducing the standard tape, trouble still exists the fault is in the reproduce circuit, if the reproduce function is normal, the fault is in the record circuit. A run through of the alignment and performance checks for the offending circuit will further isolate the trouble or may rectify it, and the faulty component or mechanical device then should be identified easily.

Troubleshooting the Reproduce Amplifier

A circuit for troubleshooting the reproduce amplifier is shown below (see also, —PARTS LOCATION POWER SUPPLY AND REPRODUCE AMPLIFIER, and foldout SCHEMATIC DIAGRAM—ELECTRONIC ASSEMBLIES).



TROUBLESHOOTING THE REPRODUCE AMPLIFIER

Disconnect the head cable at 5J3 when using this circuit. Advance an audio oscillator probe progressively through each stage (checking at the grid and plate of each stage) until the point at which a signal is available at the output. The trouble then could be in the stage immediately preceding that point. When the faulty stage is located, the individual components can be isolated by a check of resistances and voltages. Typical voltage values are shown on the foldout schematic diagram. After the completion of any troubleshooting procedures, using the circuit shown above, check the reproduce amplifier response against the appropriate curve to insure that the equipment conforms to performance characteristics.

Troubleshooting the Record Amplifier

The circuit for troubleshooting the record amplifier is shown below (see also PARTS LO-

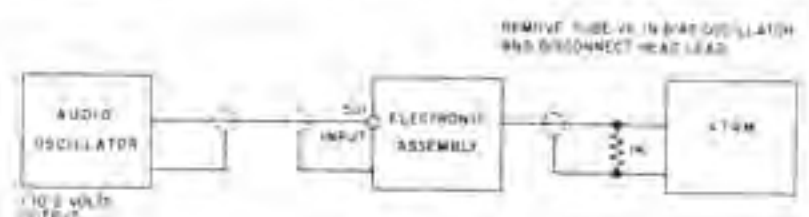

TROUBLESHOOTING THE RECORD AMPLIFIER

CATION RECORD AMPLIFIER, BIAS AND ERASE OSCILLATOR and foldout SCHEMATIC DIAGRAM—ELECTRONIC ASSEMBLIES).

Proceed as in troubleshooting the reproduce amplifier. Typical voltage readings are shown on the foldout schematic diagram. Using the circuit below, check the record amplifier against the appropriate response curve. Remove tube 1V6, and disconnect the record head lead before checking amplifier response.

Servicing and Repairing Printed Circuits

Because of the uniform wiring layout and translucent boards, printed circuits can be traced more easily than conventional circuits, troubleshooting is less difficult, and any qualified person will be able to service and repair the equipment including replacement of components by following the instructions, suggestions and procedures in this section. The translucency of the board makes locating connections and test points easier if a light bulb is placed underneath the circuit to be traced. Continuity checks and measurement of resistors, coils and some types of capacitors can be made at the component side of the etched board. Very small breaks in wiring can be located by means of a magnifying glass. The parts location illustrations and the schematic diagram in this section can be used to advantage when tracing circuitry, especially where tube sockets are concerned. Pin numbers are plainly marked.

Equipment and Tools Required

- Diagonal cutters
- Long-nosed pliers
- Pocket knife
- 1/4-inch nut driver
- Solder pick
- Small wire brush
- Pencil soldering iron
- 60/40 resin core solder

Precautions

Be careful when removing components from the board to avoid damaging the components themselves or the copper foil wiring. If damage occurs, small breaks can be joined with solder, a new foil can be cut to simulate the damaged sections, and large breaks can be repaired with

hook-up wire. When applying new foil, first remove all coatings such as flux, grease and wax from the damaged portion and place the adhesive side of the foil toward the board. With the tip of the smooth wedge-shaped soldering iron heat the new foil, sliding the tip slowly along the copper surface for about a minute to cure the bond.

Excessive pressure can crack the boards. Access to certain components may not be possible when the boards are in the chassis. To remove the board from the chassis, remove the four mounting nuts carefully. When disconnecting the edge-on harness connectors, make certain that the diagonal pliers grasping the individual connector will not strike and break an adjacent component. To prevent this type of damage, insert a screw driver or similar protective device between the diagonal pliers and the vulnerable component. A vise with protected jaws can be used to hold the boards while servicing. Avoid excessive pressure against the boards when using the vise.

Another source of damage can come from overheating during the soldering process. Excessive heat can cause breaks in the bond between the board and foil, necessitating costly repair of the foil connections. Use 60/40 resin core solder, the melting points of which is 375 degrees F. Some soldering irons are available with tip temperature of 650 degrees F., but the more skilled repair man can speed up the soldering process by using an iron with a tip temperature in the neighborhood of 750 degrees F.

Removing a Resistor

A convenient method of removing resistors is to clip the leads with cutters, leaving sufficient wire at each point so that wiring terminals remain. New components can be soldered to these remnant leads.

Replacing the Resistor

Make mechanical joints by wrapping a turn of each new resistor wire around the remnant wires left from the old component. Perform the soldering quickly and efficiently.

Solder Method of Removing and Replacing Components

On the wiring side of the board at the com-

ponent to be replaced, heat the connections with an iron until the solder melts. Quickly remove the iron and brush away the solder

using the wire brush. Two or more heating passes may be required; but take special care to avoid excessive heat.

SEL-SYNC (SELECTIVE SYNCHRONISM)

Ampex Multi-Channel Recorders are available with a feature that makes it possible to add new material in complete synchronism with previous recordings at any time. This device, called Sel-Sync, has the facility of permitting multiple re-recording (sound-on-sound) of any or all channels. The carefully designed circuit transfer panel is connected in series with the head cables of a multi-channel recorder. This panel enables the record head of any channel to function as a playback head for that channel whenever it is desired to monitor a previously recorded track while a new recording is being

made (in exact synchronism) on a different track. This means that this temporary "playback" head which is actually a record head is directly above or below the head used to record the new material, thus there is no *time lag* between what is played back and what is recorded.

When switching from the normal position to Sel-Sync, the record circuitry (both electronics and tape transport) are locked out.

Below is a simplified drawing showing Sel-Sync operation.

SEL-SYNC MAKES SYNCHRONIZATION EASY

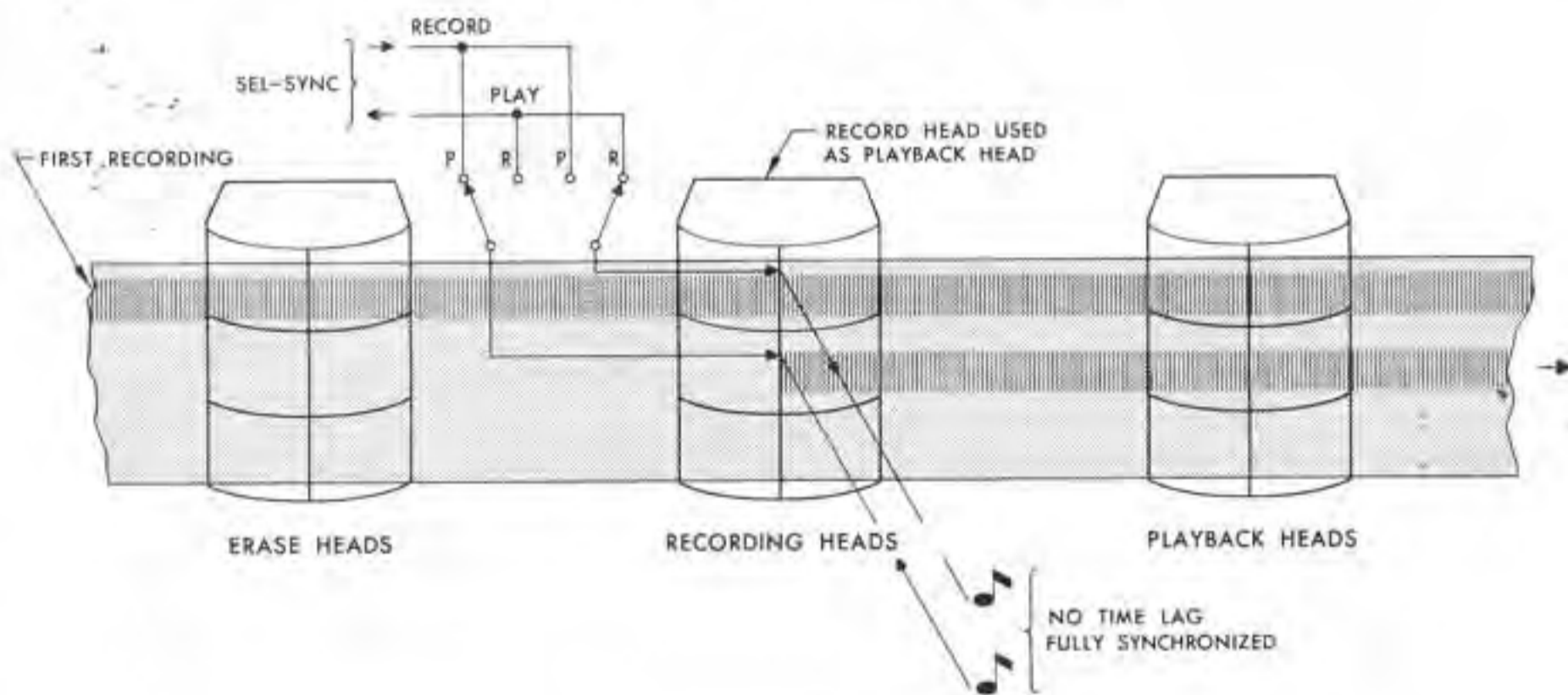

MULTICHANNEL
MODEL 300-3 and 300-4
SEL-SYNC
(used with 351 Electronics)

<i>PART DESCRIPTION</i>	<i>AMPEX PART NUMBER</i>
THREE TRACK SEL-SYNC	30685-1
CHASSIS	30683-01
COVER	30739-02
KNOB	230-031
PANEL, Backing	30684-01
PANEL, Facing	30687-01
PLATE, Identification	11750-01
SHIELD	30787-01
SWITCH	20933-01
TRANSFORMER, Interstage	563-007
WASHER, Fiber	503-006
CAPACITOR, Ceramic; .005 uf, 1000V 20%	030-076
CONNECTOR, Receptacle; Male, 3 Contacts	143-008
CONNECTOR, Receptacle; Male, 2 Contacts	143-009
CONNECTOR, Receptacle; Female, 6 Contacts	146-004
CONNECTOR, Receptacle; Male, 6 Contacts	147-011
CABLE, Interconnecting; Tape Transport (Sel-Sync)	30853-01
CABLE, Interconnecting; Tape Transport (Sel-Sync)	30853-02
CABLE, Interconnecting; reproduce (playback) (Sel-Sync)	30745-01
CABLE, Interconnecting; reproduce (playback) (Sel-Sync)	30745-02
CABLE, Interconnecting; reproduce (playback) (Sel-Sync)	30745-03
CABLE, Interconnecting; record (Sel-Sync)	30008-12
CABLE, Interconnecting; record (Sel-Sync)	30008-13
CABLE, Interconnecting; record (Sel-Sync)	30008-14
CABLE, Interconnecting; Power (Sel-Sync)	30852-01
CABLE, Interconnecting; Bias (Sel-Sync)	14943-02 or -04
ADAPTOR TEE, Bias (Sel-Sync)	169-012
FOUR TRACK SEL-SYNC	30940-01
CHASSIS	30934-01
COVER	30739-02
KNOB	230-031
PANEL, Backing	30936-01
PANEL, Facing	30935-01
PLATE, Identification	11750-01
SHIELD	30787-01
SWITCH	30933-01
CAPACITOR, Ceramic; .005 uf, 1000V, 20%	030-076
CONNECTOR, Receptacle; Male, 3 contacts	143-008
CONNECTOR, Receptacle; Male, 2 contacts	143-009
CONNECTOR, Receptacle; Female, 6 contacts	146-004
CONNECTOR, Receptacle; Female, 18 contacts	147-011
CABLE, Interconnecting; Tape Transport (Sel-Sync)	30853-05
CABLE, Interconnecting; Tape Transport (Sel-Sync)	30853-06
CABLE, Interconnecting; Tape Transport (Sel-Sync)	30853-07
CABLE, Interconnecting; Tape Transport (Sel-Sync)	30853-08
CABLE, Interconnecting; reproduce (playback) (Sel-Sync)	31069-02
CABLE, Interconnecting; reproduce (playback) (Sel-Sync)	31069-03
CABLE, Interconnecting; reproduce (playback) (Sel-Sync)	31069-04
CABLE, Interconnecting; reproduce (playback) (Sel-Sync)	31069-05
CABLE, Interconnecting; record (Sel-Sync)	31070-01
CABLE, Interconnecting; record (Sel-Sync)	31070-03
CABLE, Interconnecting; record (Sel-Sync)	31070-04
CABLE, Interconnecting; record (Sel-Sync)	31070-05

MULTICHANNEL
MODEL 300-3 and 300-4
SEL-SYNC
(used with 351 Electronics)
(continued)

PART DESCRIPTION

*AMPEX
PART NUMBER*

THREE TRACK SEL-SYNC

CABLE, Extension erase (Sel-Sync)	30825-06
CABLE, Extension erase (Sel-Sync)	30825-07
CABLE, Extension erase (Sel-Sync)	30825-08
CABLE, Extension erase (Sel-Sync)	30825-09
CABLE, Interconnecting; Power (Sel-Sync)	30852-01
CABLE, Interconnecting; Bias (Sel-Sync)	14943-02 or -04
CABLE, Interconnecting; Bias (Sel-Sync)	14943-03
ADAPTOR TEE; Bias (Sel-Sync)	169-012

ELECTRONIC ASSEMBLY PARTS LIST
MULTICHANNEL MODEL 300-2, 300-3, AND 300-4
CATALOG NUMBER 30960-05 AND 30960-06

REF. NO.	PART DESCRIPTION	AMPEX PART NO.
1C1	CAPACITOR, fixed: paper, .15 uf $\pm 20\%$, 400 vdcw; Cornell Dubilier Part No. BC4P15 $\pm 20\%$	035-205
1C2	CAPACITOR: electrolytic -- 10 uf, 450 volt; 20 uf, 450 volt; 10 uf, 350 volt --	30770-01
1C3	CAPACITOR, fixed: ceramic, .02 uf $+80\%$ -20%, 500 vdcw, Sprague Part No. 36C205	030-059
1C4	Same as 1C3	030-059
1C5	Same as 1C3	030-059
1C8	CAPACITOR, paper: tubular, .1 mfd, $+10\%$, 400 vdcw; MIL-C-25; CPO5A3EE104K	035-067
1C9	Same as 1C3	030-059
1C10	CAPACITOR, fixed: paper, .47 uf $\pm 20\%$, 400 vdcw; Cornell Dubilier Part No. BC4P47 $\pm 20\%$	035-206
5C13	CAPACITOR, variable: mica, 15-130 mmfd, 175 vdcw; El Menco Part No. 302 (type 30)	038-002
2C14	Same as 1C3	030-059
2C15	CAPACITOR, fixed: mica, 750 uuf $\pm 5\%$, 500 vdcw; El Menco Part No. CM20C751J	034-144
3C16	CAPACITOR, electrolytic -- 15 uf, 350 volt; 15 uf, 350 volt; 75 uf, 450 volt; 20 uf, 450 volt --	30769-02
2C17	CAPACITOR, paper: tubular, .15 mfd, $\pm 20\%$, 400 vdcw; Sprague Part No. 89P15404	035-205
2C18	Same as 1C3	030-059
2C19	Same as 1C3	030-059
2C20	CAPACITOR, fixed: ceramic, 150 uuf, $\pm 20\%$, 500 vdcw; Sprague Part No. 40C218	030-046
2C21	Same as 1C3	030-059
2C22	CAPACITOR, ceramic: disc, .1 mfd, $+80$ -20%, 50 vdcw; Sprague Part No. 33641	030-063
4C23	CAPACITOR, fixed: ceramic, 2X .001 uf, 500 vdcw; Erie Part No. 812-, 001	030-004
5C24	CAPACITOR, paper: tubular, .0047 mfd, $\pm 20\%$, 600 vdcw; Sprague Part No. 73P47206	035-028
5C25	Same as 5C24	035-028
3C26	CAPACITOR, fixed: electrolytic, 20 uf, 450 vdcw; Cornell Dubilier Part No. BR10422	031-144
3C27	Same as 1C3	030-059
3C28	CAPACITOR: electrolytic, 4000 uf, 15 volt	30769-01
3C29	CAPACITOR, fixed: ceramic, .01 uf, $\pm 20\%$, 1000 vdcw; Sprague Part No. 33C35A	030-045
3C30	Same as 3C29	030-045
1C32	CAPACITOR, mica: axial, .00035 mfd, $\pm 1\%$ 500 vdcw; Cornell Dubilier Part No. 5A5T35	034-169
4C40	CAPACITOR, variable: mica, 100-550 mmfd, 175 vdcw; El Menco Part No. Type 30	038-009
5C33	CAPACITOR, variable: mica, 275-970 mmfd, 175 vdcw; El Menco Part No. 306 (type 30)	038-003
5C34	CAPACITOR, mica: axial, .00082 mfd, $\pm 5\%$, 300 vdcw; MIL-C-5A; CM20C821J	034-016
1C35	Same as 1C32	034-169
1C36	CAPACITOR, fixed: mica, .001 uf $\pm 5\%$, 500 vdcw; Cornell Dubilier Part No. SAT535	034-147
4C37	CAPACITOR, fixed: ceramic, .01 uf, 500 vdcw; Erie Part No. 811-01	030-002

REF. NO.	PART DESCRIPTION	AMPEX PART NO.
5C39	CAPACITOR, mica: axial, .000033 mfd $\pm 5\%$, 500 vdcw; Cornell Dubilier Part No. 22A5Q33	034-168
4C41	Same as 4C40	038-009
4C42	CAPACITOR, paper: tubular, .0051 mfd, $\pm 5\%$, 400 vdcw; Sprague Part No. 109P512J4	035-283
4C43	CAPACITOR, electrolytic: tubular, 10 mfd, -10+150% 150 vdcw; Cornell Dubilier Part No. BBR-10-150	031-157
4C44	CAPACITOR, variable: mica, 450-1390 mmfd, 350 vdcw; El Menco Part No. 308	038-014
4C45	CAPACITOR, paper: tubular, .012 mfd, $\pm 5\%$, 200 vdcw; Sprague Part No. 109P12552	035-246
4C47	CAPACITOR, variable: mica, 550-1600 mmfd, 250 vdcw; El Menco Part No. 309	038-015
4C48	CAPACITOR, mica: axial, .00068 mfd, $\pm 5\%$, 500 vdcw; MIL-C-5A: CM25D681J	034-013
6CR1	RECTIFIER, selenium; single phase, center tap, 26 volt ac rms max. in -- 1.25 amp dc max. out; General Electric Part No. 6RS5WH5	581-001
4CR2	RECTIFIER, selenium; half wave, max input 90V. ac; 4 cell, as rms max. in -- .025 amp dc max. out; General Electric Part No. 6RS20PH4RAD1	582-031
5F1	FUSE, 1/2 amp; 250 volt, slow blow; little fuse; Littlefuse Part No. 313.500	070-026
411	POST LIGHT, 1/4 watt neon without internal resistor; Drake Mfg. Part No. 105	132-003
5J1	CONNECTOR, receptacle; female, 3 contact; Cannon Part No. XL-3-13	146-007
5J2	CONNECTOR, receptacle; male, 2 contact; AN3102A-10SL-4P	143-009
5J3	CONNECTOR, receptacle; male, 3 contact; AN3102A-10S-3P	143-008
5J4	PHONE JACK, open circuit type, 2 conductor; Switchcraft Part No. 11	148-015
5J5	CONNECTOR, receptacle; male, 3 contact; Cannon Part No. XL-3-14	147-004
4J6	Same as 5J4	148-015
5J7	CONNECTOR, receptacle; male, 6 contact; Jones Part No. P-306AB	147-011
5J9	CONNECTOR, receptacle; female, 1 contact; Amphenol Part No. 83-1R	146-067
5J10	CONNECTOR, receptacle; male, 1 contact; AN3102A-105-2P	143-010
3K1	RELAY, record: 115V dc coil	30763-01
4K2	RELAY, concurrent record; 115V dc coil	020-066
4K3	RELAY, bias lock; 115V dc coil	020-066
4M1	METER, vu: frosted lamps 6.3 volt, .3 amp	30667-01
4R1	RESISTOR, fixed: carbon, .1 meg ohm $\pm 10\%$, $\frac{1}{2}$ watt; MIL-R-11: RC20GF104K	041-072
4R2	RESISTOR, fixed: carbon, 100 ohm, $\frac{1}{2}$ watt, 10%; MIL-R-11A, RC20GF101K	041-038
4R3	Same as 4R2	041-038
4R4	RESISTOR, fixed: carbon, 20K ohms, $\pm 5\%$, $\frac{1}{2}$ watt; MIL-R-11: RC20GF202J	041-356
4R5	RESISTOR, fixed: carbon, 82K ohms, $\pm 10\%$, $\frac{1}{2}$ watt; MIL-R-11: RC20GF823K	041-071
1R6	RESISTOR, fixed: film, .1 meg $\pm 1\%$, $\frac{1}{2}$ watt; Electra Part No. Type DC- $\frac{1}{2}$	042-092
1R7	RESISTOR, fixed: film, 2700 ohm, $\frac{1}{2}$ watt, 10% MIL-R-10509A, RN15R2701F	042-123

REF. NO.	PART DESCRIPTION	AMPEX PART NO.
1R8	RESISTOR, fixed: carbon, 1 meg, $\frac{1}{2}$ watt; MIL-R-11A, RC20GF105K	041-031
4R9	RESISTOR, variable: carbon, .1 meg, 2 watts; Allen Bradley Part No. JA1041	044-015
1R10	RESISTOR, fixed: carbon, .1 meg, $\frac{1}{2}$ watt; MIL-R-11A, RC20GF104K	041-072
1R11	RESISTOR, fixed: carbon, 3.3K ohms, $\pm 10\%$, $\frac{1}{2}$ watt; MIL-R-11: RC20GF332K	041-054
4R12	RESISTOR, variable: carbon, .25 meg, 1/4 watt, 20%; CTC Part No. Type PM-45	044-179
1R13	RESISTOR, fixed: carbon, 27K ohms, $\frac{1}{2}$ watt, 10%; MIL-R-11A, RC20GF273K	041-065
1R14	RESISTOR, fixed: carbon, .33 meg, $\frac{1}{2}$ watt; MIL-R-11A, RC20GF334K	041-078
1R15	Same as 1R8	041-031
1R16	RESISTOR, fixed: carbon, 1500 ohms, $\frac{1}{2}$ watt; MIL-R-11A, RC20GF152K	041-050
1R17	RESISTOR, fixed: carbon, 47K ohms, $\pm 5\%$, $\frac{1}{2}$ watt; MIL-R-11: RC20GF473J	041-020
1R18	RESISTOR, fixed: carbon, .12 meg, $\frac{1}{2}$ watt, 5%; MIL-R-11A, RC20GF124J	041-318
1R19	RESISTOR, fixed: carbon, 22K ohm, 1 watt, 10%; MIL-R-11A, RC32GF223K124J	041-162
1R20	Same as 1R8	041-031
1R21	RESISTOR, fixed: carbon, 220 ohms, $\frac{1}{2}$ watt, 10%; MIL-R-11A, RC20GF221K	041-040
1R22	RESISTOR, fixed: carbon, 2.2K ohms, $\pm 10\%$, $\frac{1}{2}$ watt; MIL-R-11: RC20GF222K	041-052
1R23	RESISTOR, fixed: carbon, 8200 ohms, $\frac{1}{2}$ watt, 10%; MIL-R-11A, RC20GF822K	041-059
5R24	RESISTOR, variable: wirewound, 500 ohm, 2 watts, 20%; Claro Part No. 39-500	044-178
2R25	RESISTOR, fixed: carbon, .33 meg ohms, $\pm 10\%$, $\frac{1}{2}$ watt; MIL-R-11: RC20GF334K	041-078
2R26	RESISTOR, fixed: carbon, .47 meg, $\frac{1}{2}$ watt, 10%; MIL-R-11A, RC20GF474K	041-080
2R27	RESISTOR, fixed: film, .33 meg $\pm 1\%$, $\frac{1}{2}$ watt; Electra Part No. Type DC- $\frac{1}{2}$	042-100
2R28	RESISTOR, fixed: film, 1500 ohm, $\frac{1}{2}$ watt, 1%; Electra Part No. DC- $\frac{1}{2}$	042-076
2R29	RESISTOR, fixed: carbon, 8.2 meg ohm, $\pm 10\%$, $\frac{1}{2}$ watt; MIL-R-11: RC20GF825K	041-381
2R31	RESISTOR, fixed: film, 68K ohm, $\frac{1}{2}$ watt, 1%; Electra Part No. Type DC- $\frac{1}{2}$	042-088
3R32	RESISTOR, fixed: carbon, 39K ohm, $\frac{1}{2}$ watt, 10%; MIL-R-11A, RC20GF393K	041-067
2R33	RESISTOR, fixed: carbon, 10 meg ohms, $\pm 10\%$, $\frac{1}{2}$ watt; MIL-R-11: RC20GF106K	041-090
2R34	RESISTOR, fixed: carbon, .22 meg, $\frac{1}{2}$ watt, 10%; MIL-R-11A, RC20GF224K	041-076
3R35	Same as 1R13	041-065
4R36	RESISTOR, variable: carbon, .25 meg, 2 watts, 10%; Allen Bradley Part No. CA2541, SK3056	044-128
2R37	Same as 1R8	041-031
2R38	Same as 1R16	041-050
2R39	Same as 1R8	041-031
2R40	RESISTOR, fixed carbon, 82K ohm, $\frac{1}{2}$ watt, 10%; MIL-R-11A, RC20GF823K	041-071

REF. NO.	PART DESCRIPTION	AMPEX PART NO.
----------	------------------	----------------

2R41	Same as 1R16	041-050
2R42	Same as 2R34	041-076
2R43	Same as 2R34	041-076
2R44	Same as 1R8	041-031
2R45	Same as 1R8	041-031
2R46	RESISTOR, fixed: carbon, 1K ohm, $\frac{1}{2}$ watt, 10%; MIL-R-11A, RC20GF102K	041-048
2R47	RESISTOR, fixed: carbon, 15k ohms, $\pm 10\%$, $\frac{1}{2}$ watt; MIL-R-11: RC206F	041-062
5R48	RESISTOR, fixed: carbon, 560 ohm, $\frac{1}{2}$ watt, 10%; MIL-R-11A, RC20GF561K	041-045
2R49	Same as 3R32	041-067
6R50	RESISTOR, fixed: carbon, 1.5K ohm, $\frac{1}{2}$ watt, 10%; MIL-R-11A, RC20GF152K	041-050
6R51	RESISTOR, fixed: carbon, 4.7K ohm, $\frac{1}{2}$ watt, 10%; MIL-R-11A, RC20GF472J	041-013
6R52	RESISTOR, fixed: carbon, 8.2K ohm, $\frac{1}{2}$ watt, 5%; MIL-R-11A, RC20GF822J	041-309
6R53	RESISTOR, fixed: carbon, 820 ohm, $\frac{1}{2}$ watt, 5%; MIL-R-11A, RC20GF821J	041-317
3R54	RESISTOR, fixed: carbon, 1.5K ohm, 1 watt, 10%; MIL-R-11A, RC32GF152K	041-148
3R55	Same as 3R54	041-148
3R56	Same as 4R2	041-038
3R57	Same as 4R2	041-038
3R58	RESISTOR, fixed: carbon, 15K ohm, $\frac{1}{2}$ watt, 10%; MIL-R-11A, RC20GF153K	041-062
1R59	RESISTOR, fixed: carbon, 1.5K ohm, 2 watts, 10%; MIL-R-11A, RC42GF152K	041-204
3R60	RESISTOR, fixed: wirewound, 1.5 ohm, 1 watt, 10%; IRC Type BW-1	043-286
1R61	RESISTOR, fixed: carbon, 4.7K ohms, $\pm 10\%$, $\frac{1}{2}$ watt; MIL-R-11: RC20GF472K	041-056
1R62	Same as 1R61	041-056
1R63	RESISTOR, variable: carbon, 10K ohm, 044-171, 1/4 watt, 30%, Chicago Telephone Supply Part No. UPM-45 SPEC3471	044-171
1R64	RESISTOR, fixed: carbon, 8.2 ohm, 1 watt, 5%; MIL-R-11A, RC32GF825j	041-319
1R65	Same as 2R34	041-076
4R67	RESISTOR, fixed: carbon, 12K ohms, $\pm 5\%$, $\frac{1}{2}$ watt; MIL-R-11: RC20GF123J	041-420
4R69	RESISTOR, variable: carbon, .1 meg, 2/10 watt, 20%; Chicago Telephone Supply Type 70 (LT)	044-186
4R70	RESISTOR, fixed: carbon, .220 ohm, $\frac{1}{2}$ watt, 10%; MIL-R-11A, RC20GF221K	041-040
4R71	RESISTOR, fixed: carbon, 15K ohms, $\pm 5\%$, $\frac{1}{2}$ watt; MIL-R-11: RC20GF153J	041-254
4R72	RESISTOR, fixed: carbon, 4700 ohm, $\frac{1}{2}$ watt, 10%; MIL-R-11A, RC20GF472K	041-056
4R73	RESISTOR, fixed: carbon, .22 meg ohms, $\pm 10\%$; 2 watts; MIL-R-11: RC20GF224K	042-228
2R75	RESISTOR, fixed: carbon, .68 meg ohms, $\pm 10\%$, $\frac{1}{2}$ watt; MIL-R-11: RC20GF684K	041-082
4R76	Same as 4R72	041-056
4S1	SWITCH, rotary: INPUT TRANSFER, 3 position	30760-01
4S2	SWITCH, rotary: EQUALIZATION, 3 position	30891-01
4S3	SWITCH, rotary: METER AND OUTPUT, 4 position	30762-01
5S4	SWITCH, rotary: LINE TERM, 3P4T; Oak Part No. 590p6-23	122-016
4S5	SWITCH, toggle: POWER, SPST; Carling Part No. 110-B-73	120-005

REF. NO.	PART DESCRIPTION	AMPEX PART NO.
4S6	SWITCH, rotary, RECORD, pushbutton SPST, normally open; Arrow H and H Part No. 3391BSA	120-013
6T1	TRANSFORMER, microphone input	17331-01
5T2	TRANSFORMER, input	6299-01
	<u>Low Impedance Heads Only</u>	
6T3	TRANSFORMER, output	30633-01
6T4	TRANSFORMER, power	30634-01
1T5	TRANSFORMER, oscillator	30766-01
1V1	TUBE, electron: 12AX7, miniature, 9 pin; Telefunken Part Number	012-024
1V2	TUBE, electron: 12AT7, miniature, 9 pin; RCA Part Number	012-034
2V3	Same as 1V1	012-024
2V4	Same as 1V1	012-024
2V5	TUBE, electron: 12AU7, miniature, 9 pin; RCA Part Number	012-107
1V6	Same as 2V5	012-107
3V7	Same as 2V5	012-107
	*BOARD ASSEMBLY, power supply	30754-01
	*BOARD ASSEMBLY, record: 7 $\frac{1}{2}$ -15 ips	30963-03
	*BOARD ASSEMBLY, reproduce: 7 $\frac{1}{2}$ -15 ips	30962-03
	FACING PANEL	5711-03
	HARNESS ASSEMBLY	30966-03
	KNOB, large, skirted: Reproduce & Record Level Control	230-004
	KNOB, small, skirted: Equalization and Output	230-003
	KNOB, small with pointer: Input and Line Termination	230-008
	POST, fuse: F1 and F2	085-001
	NUT, sleeve, sub chassis mount	21078-01
	SHIELD, tube, for all except V7	160-012
	SHIELD, tube: V7	160-043
	SHOCKMOUNT	350-015
	SOCKET, tube: 7 pin	150-067
	SOCKET, tube: 9 pin	30818-01
	EQUALIZER BRACKET ASSEMBLY (COMPLETE)	30920-02
	KNOB ASSEMBLY: editing	1917-00
	KNOB ASSEMBLY: holddown (for 1/4-inch and $\frac{1}{2}$ -inch machines)	9093-00
	KNOB ASSEMBLY: holddown (for 1-inch machines)	5881-00
	REEL ADAPTOR	973-00
	CABLE ASSEMBLY, power interconnecting (300-2)	30821-01
	CABLE ASSEMBLY, bias (300-3)	14943-04
	CABLE ASSEMBLY, bias (300-4)	14943-03
	CABLE ASSEMBLY, bias (300-2)	14943-02
	CABLE ASSEMBLY, power interconnecting(300-3)	30851-01
	CORD SET	084-005
	ADAPTOR TEE: coax	169-012
	PANEL, backing (7 inch)	6962-00
	PANEL, facing (7 inch)	6963-00
	PANEL, backing	30828-01
	PANEL, facing	30829-01
	CONNECTOR, plug: female, 3 contact; Cannon Part No. XL-3-11	144-003
	CONNECTOR, plug: male, 3 contact; Cannon Part No. XL-3-12	145-009
	SPACER, base plate head assembly	5888-00
	BASE, editing knob assembly	1916-00

ELECTRONIC ASSEMBLY PARTS LIST
MULTICHANNEL MODEL 300-2, 300-3 AND 300-4
CATALOG NUMBER 30750-09 AND 30750-10

REF. NO.	PART DESCRIPTION	AMPEX PART NO.
1C1	CAPACITOR, fixed: paper, .15 uf \pm 20%, 400 vdcw; Cornell Dubilier Part No. BC4P15 \pm 20%	035-205
1C2	CAPACITOR: electrolytic — 10 uf, 450 volt; 20 uf, 450 volt; 10 uf, 350 volt —	30770-01
1C3	CAPACITOR, fixed: ceramic, .02 uf +80% -20%, 500 vdcw, Sprague Part No. 36C205	030-059
1C4	Same as C3	
1C5	Same as C3	
1C6	CAPACITOR, fixed: paper, .0047 uf \pm 5%, 400 vdcw; Cornell Dubilier Part No. ST4D47	035-026
1C8	CAPACITOR, fixed: paper, .02 uf \pm 5%, 400 vdcw; Cornell Dubilier Part No. Type PJ	035-020
1C9	Same as C3	
1C10	CAPACITOR, fixed: paper, .47 uf \pm 20%, 400 vdcw; Cornell Dubilier Part No. BC4P47 \pm 20%	035-206
1C11	Same as C6 (.0047)	
1C11	CAPACITOR, fixed: paper, .0082 uf \pm 5%, 200 vdcw; Cornell Dubilier Part No. 109P	035-030
1C12	CAPACITOR, fixed: paper, .0022 uf \pm 5%, 400 vdcw; Sprague Part No. 109P22254	035-204
5C13	CAPACITOR, variable: mica, 15-130 uuf, 175 vdcw; El Menco Part No. 302 (type 30)	038-005
2C14	Same as C3	
2C15	CAPACITOR, fixed: mica, 750 uuf \pm 5%, 500 vdcw; El Menco Part No. CM20C751J	034-144
3C16	CAPACITOR, electrolytic — 15 uf, 350 volt; 15 uf, 350 volt; 75 uf, 450 volt; 20 uf, 450 volt—	30769-02
2C17	CAPACITOR, fixed: paper, .1 uf \pm 20%, 400 vdcw; CDST4P1 (20%)	035-069
2C18	Same as C3	
2C19	Same as C3	
2C20	CAPACITOR, fixed: ceramic, 150 uuf, \pm 20%, 500 vdcw; Sprague Part No. 40C218	030-046
2C21	Same as C3	
2C22	CAPACITOR, fixed: ceramic, .05 uf +80% -20%, 500 vdcw; Sprague Part No. 5HK-S5	030-031
4C23	CAPACITOR, Fixed: ceramic, 2X .001 uf, 500 vdcw; Erie Part No. 812-.001	030-004
5C24	CAPACITOR, fixed: ceramic, .0047 uf, \pm 2%, 500 vdcw; JAN-C-20A: CC36CH470G	030-028
5C25	Same as C24	
3C26	CAPACITOR, fixed: electrolytic, 20 uf, 450 vdcw; Cornell Dubilier Part No. BR10422	031-144
3C27	Same as C3	
3C28	CAPACITOR: electrolytic, 4000 uf, 15 volt	30769-01
3C29	CAPACITOR, fixed: ceramic, .01 uf, \pm 20%, 1000 vdcw; Sprague Part No. 33C35A	030-045

When ordering replacement parts always include the following information: Equipment Type; Equipment Serial Number; Ampex Part or Catalog Number; and Description of Part. DO NOT simply use the schematic reference number.

REF. NO.	PART DESCRIPTION	AMPEX PART NO.
3C30	Same as C29	
5C32	CAPACITOR, fixed: mica, 820 uuf, $\pm 5\%$, 300 vdcw; MIL-C-5A: CM20B821J	034-016
4C40	CAPACITOR, variable; mica, 275-970 uuf, 175 vdcw; El Menco: 306 Type 30	038-003
1C34	CAPACITOR, fixed: mica, 350 uuf 1% , 50 vdcw; Cornell Dubilier Part No. SA5T35	034-169
1C35	Same as 1C34	
1C36	CAPACITOR, fixed: mica, .001 uf $\pm 5\%$, 500 vdcw; Cornell Dubilier Part No. SAT535	034-147
4C37	CAPACITOR, fixed: ceramic, .01 uf, 500 vdcw; Erie Part No. 811-01	030-002
4C41	CAPACITOR, variable: mica, 450 -1390 uufd, 350 vdcw; El Menco: 308	038-014
4C42	CAPACITOR, paper: tubular, .012 mfd, 200 vdcw; Sprague Part No. 65p18352	035-246
4C43	CAPACITOR, electrolytic: tubular, 10 mfd, -10 +150%, 150 vdcw; Cornell Dubilier Part No. BBR-10-150	031-157
4C44	Same as 4C41	
4C45	Same as 4C42	
6CR1	RECTIFIER, selenium; single phase, center tap, 26 volt ac rms max. in -- 1.26 amp dc max. out; General Electric Part No. 6RS5WH5	581-001
4CR2	RECTIFIER, selenium; half wave, Max input 90V. ac; 4 cell, as rms max. in -- .025 amp dc max. out; General Electric Part No. 6RS20PH4RAD1	582-031
5F1	FUSE; 1/2 amp; 250 volt, slow blow; little fuse Littlefuse Part No. 313.500	070-026
4I1	POST LIGHT, 1/4 watt neon without internal resistor; Drake Mfg. Part No. 105	132-003
5J1	CONNECTOR, receptacle; female, 3 contact; Cannon Part No. XL-3-13	146-007
5J2	CONNECTOR, receptacle; male, 2 contact; AN3102A-10SL-4P	143-009
5J3	CONNECTOR, receptacle; male, 3 contact; AN3102A-10S-3P	143-008
5J4	PHONE JACK, open circuit type, 2 conductor; Switchcraft Part No. 11	148-015
5J5	CONNECTOR, receptacle; male, 3 contact; Cannon Part No. XL-3-14	147-004
4J6	Same as 5J4	
5J7	CONNECTOR, receptacle; male, 6 contact; Jones Part No. P-306AB	147-011
5J9	CONNECTOR, receptacle; female, 1 contact; Amphenol Part No. 83-1R	146-067
5J10	CONNECTOR, receptacle; male, 1 contact; AN3102A-105-2P	143-010
3K1	RELAY, record; 115 V dc coil	30763-01
4K2	RELAY, concurrent record; 115 V dc coil	020-066
4K3	RELAY, bias lock; 115 V dc coil	020-066
1L1	CHOKE, rf; 20 mh, 125 ma	30767-01

When ordering replacement parts always include the following information: Equipment Type; Equipment Serial Number; Ampex Part or Catalog Number; and Description of Part. DO NOT simply use the schematic reference number.

REF. NO.	PART DESCRIPTION	AMPEX PART NO.
4M1	METER, vu: frosted lamps 6.3 volt, .3 amp	30667-01
4R1	RESISTOR, fixed: carbon, .15 meg, 1/2 watt; MIL-R-11A, RC20GF154K	041-074
4R2	RESISTOR, fixed: carbon, 100 ohm, 1/2 watt, 10%; MIL-R-11A, RC20GF101K	041-038
4R3	Same as R2	
4R4	RESISTOR, fixed: carbon, 33K ohm, 1/2 watt, 10%; MIL-R-11A, RC20GF333K	041-066
4R5	RESISTOR, fixed: carbon, .12 meg, 1/2 watt, 10%; MIL-R-11A, RC20GF124K	041-073
1R6	RESISTOR, fixed: film, .1 meg \pm 1%, 1/2 watt; Electra Part No. Type DC-1/2	042-092
1R7	RESISTOR, fixed: film, 2700 ohm, 1/2 watt, 10%; MIL-R-10509A, RN15R2701F	043-123
1R8	RESISTOR, fixed: carbon, 1 meg, 1/2 watt; MIL-R-11A, RC20GF105K	041-031
4R9	RESISTOR, variable: carbon, .1 meg, 2 watts; Allen Bradley Part No. JA1041	044-015
1R10	RESISTOR, fixed: carbon, .1 meg, 1/2 watt; MIL-R-11A, RC20GF104K	041-072
1R11	RESISTOR, fixed: carbon, 4700 ohm, 1/2 watt, 10%; MIL-R-11A, RC20GF472K	041-056
4R12	RESISTOR, variable: carbon, .25 meg, 1/4 watt, 20%; CTC Part No. type PM-45	044-179
1R13	RESISTOR, fixed: carbon, 27K ohm, 1/2 watt, 10%; MIL-R-11A, RC20GF273K	041-065
1R14	RESISTOR, fixed: carbon, .33 meg, 1/2 watt; MIL-R-11A, RC20GF334K	041-078
1R15	Same as R8	
1R16	RESISTOR, fixed: carbon, 1500 ohm, 1/2 watt; MIL-R-11A, RC20GF152K	041-050
1R17	RESISTOR, fixed: carbon, 22K ohm, 1/2 watt, 5%; MIL-R-11A, RC20GF223J	041-016
1R18	RESISTOR, fixed: carbon, .12 meg, 1/2 watt, 5%; MIL-R-11A, RC20GF124J	041-318
1R19	RESISTOR, fixed: carbon, 22K ohm, 1 watt, 10%; MIL-R-11A, RC32GF223K124J	041-162
1R20	Same as R8	
1R21	RESISTOR, fixed: carbon, 220 ohm, 1/2 watt, 10%; MIL-R-11A, RC20GF221K	041-040
1R22	RESISTOR, fixed: carbon, 3700 ohm, 1/2 watt, 5%; MIL-R-11A, RC20GF272J	041-278
1R23	RESISTOR, fixed: carbon, 8200 ohm, 1/2 watt, 10%; MIL-R-11A, RC20GF822K	041-059
5R24	RESISTOR, variable: wirewound, 500 ohm, 2 watts, 20%; Claro Part No. 39-500	044-178
2R25	RESISTOR, fixed: carbon, .33 meg, 1/4 watt, 10%; Allen Bradley Part No. Type CB	041-325
2R25	RESISTOR, fixed: carbon, .47 meg, 1/2 watt, 10%; MIL-R-11A, RC20GF474K (Low impedance heads)	041-080
2R26	RESISTOR, fixed: carbon, .47 meg, 1/2 watt, 10%; MIL-R-11A, RC20GF474K	041-080

When ordering replacement parts always include the following information: Equipment Type; Equipment Serial Number; Ampex Part or Catalog Number; and Description of Part. DO NOT simply use the schematic reference number.

REF. NO.	PART DESCRIPTION	AMPEX PART NO.
2R27	RESISTOR, fixed: film, .33 meg \pm 1%, 1/2 watt; Electra Part No. Type DC-1/2	042-100
2R28	RESISTOR, fixed: film: 1500 ohm, 1/2 watt, 1%; Electra Part No. DC-1/2	042-076
2R29	RESISTOR, fixed: film, 10 meg, 1/2 watt, 10%; MIL-R-11 RC20GF106K	041-090
2R31	RESISTOR, fixed: film, 68K ohm, 1/2 watt, 1%; Electra Part No. Type DC-1/2	042-088
3R32	RESISTOR, fixed: carbon, 39K ohm, 1/2 watt, 10%; MIL-R-11A, RC20GF393K	041-067
2R33	Same as R29	
2R34	RESISTOR, fixed: carbon, .22 meg, 1/2 watt, 10%; MIL-R-11A, RC20GF224K	041-076
3R35	Same as R13	
4R36	RESISTOR, variable: carbon, .25 meg, 2 watts, 10%; Allen Bradley Part No. CA2541, SD3056	044-128
2R37	Same as R8	
2R38	Same as R16	
2R39	Same as R8	
2R40	RESISTOR, fixed carbon, 82K ohm, 1/2 watt, 10%; MIL-R-11A, RC20GF823K	041-071
2R41	Same as R16	
2R42	Same as R34	
2R43	Same as R34	
2R44	Same as R8	
2R45	Same as R8	
2R46	RESISTOR, fixed: carbon, 1K ohm, 1/2 watt, 10%; MIL-R-11A, RC20GF102K	041-048
2R47	Same as R13	
5R48	RESISTOR, fixed: carbon, 560 ohm, 1/2 watt, 10%; MIL-R-11A, RC20GF561K	041-045
2R49	Same as R32	
6R50	RESISTOR, fixed: carbon, 1.5K ohm, 1/2 watt, 10%; MIL-R-11A, RC20GF152K	041-050
6R51	RESISTOR, fixed: carbon, 4.7K ohm, 1/2 watt, 10%; MIL-R-11A, RC20GF472J	041-013
6R52	RESISTOR, fixed: carbon, 8.2K ohm, 1/2 watt, 5%; MIL-R-11A, RC20GF822J	041-309
6R53	RESISTOR, fixed: carbon, 820 ohm, 1/2 watt, 5%; MIL-R-11A, RC20GF821J	041-317
3R54	RESISTOR, fixed: carbon, 1.5K ohm, 1 watt, 10%; MIL-R-11A, RC32GF152K	041-148
3R55	Same as R54	
3R56	Same as R2	041-055
3R57	Same as R2	
3R58	RESISTOR, fixed: carbon, 15K ohm, 1/2 watt, 10%; MIL-R-11A, RC20GF153K	041-062
1R59	RESISTOR, fixed: carbon, 1.5K ohm, 2 watts, 10%; MIL-R-11A, RC42GF152K	041-204
3R60	RESISTOR, fixed: wirewound, 1.5 ohm, 1 watt, 10%; IRC Type BW-1	043-286
1R61	Same as R11	
1R62	Same as R11	

When ordering replacement parts always include the following information: Equipment Type; Equipment Serial Number; Ampex Part or Catalog Number; and Description of Part. DO NOT simply use the schematic reference number.

REF. NO.	PART DESCRIPTION	AMPEX PART NO.
1R63	RESISTOR, variable: carbon, 10K ohm, 044-171, 1/4 watt, 30%, Chicago Telephone Supply Part No. UPM-45 SPEC3471	044-171
1R64	RESISTOR, fixed: carbon, 8.2 ohm, 1 watt, 5%; MIL-R-11A, RC32GF825J	041-319
1R65	Same as R34	
4R66	RESISTOR, variable: carbon, 10K ohm, 2/10 watt, 20%; Chicago Telephone Supply Type 70 (LT)	044-187
4R67	RESISTOR, fixed: carbon, 1200 ohm, 1/2 watt, 1%; MIL-R-10509A, RN15R1201F	042-126
4R68	RESISTOR, fixed: carbon, 750 ohm, 1/2 watt, 5%; MIL-R-11A, RC20GF751J	041-007
4R69	RESISTOR, variable: carbon, .1 meg, 2/10 watt, 20%; Chicago Telephone Supply Type 70 (LT)	044-186
4R70	RESISTOR, fixed: carbon, .220 ohm, 1/2 watt, 10%; MIL-R-11A, RC20GF221K	041-040
4R71	RESISTOR, fixed: carbon, 20K ohm, 1/2 watt, 5%; MIL-R-11A, RC20GF202J	041-356
4R72	RESISTOR, fixed: carbon, 4700 ohm, 1/2 watt, 10%; MIL-R-11A, RC20GF472K	041-056
4R73	RESISTOR, fixed: carbon, 7500 ohm, 1/2 watt, 5%; MIL-R-11A, RC20GF752J	041-361
4S1	SWITCH, rotary: INPUT TRANSFER, 3 position	30760-01
4S2	SWITCH, rotary: EQUALIZATION, 3 position	30891-01
4S3	SWITCH, rotary: METER AND OUTPUT, 4 position	30762-01
5S4	SWITCH, rotary: LINE TERM, 3P4T; Oak Part No. 590p6-23	122-016
4S5	SWITCH, toggle: POWER, SPST; Carling Part No. 110-B-73	120-005
4S6	SWITCH, rotary: RECORD, pushbutton SPST, normally open; Arrow H and H Part No. 3391BSA	120-013
6T1	TRANSFORMER, microphone input	17331-01
5T2	TRANSFORMER, input <u>Low Impedance Heads Only</u>	6299
6T3	TRANSFORMER, output	30633-01
6T4	TRANSFORMER, power	30634-01
1T5	TRANSFORMER, oscillator	30766-01
1V1	TUBE, electron: 12AX7	012-105
1V2	TUBE, electron: 12AT7	012-034
2V3	Same as V1	
2V4	Same as V1	
2V5	TUBE, electron: 12AU7	012-107
1V6	Same as V5	
3V7	TUBE, electron: 6X4	012-050
	*BOARD ASSEMBLY, power supply	30754-01
	*BOARD ASSEMBLY, record: 7-1/2-15 ips	30755-03
	*BOARD ASSEMBLY, reproduce: 7-1/2-15 ips	30756-03
	FACING PANEL	5711-03
	HARNESS ASSEMBLY	30819-03
	KNOB, large, skirted: Reproduce and Record Level Control	230-004
	KNOB, small, skirted: Equalization and Output	230-003
	KNOB, small with pointer: Input and Line Termination	230-008
	POST, fuse: F1 and F2	085-001

When ordering replacement parts always include the following information: Equipment Type; Equipment Serial Number; Ampex Part or Catalog Number; and Description of Part. DO NOT simply use the schematic reference number.

REF. NO.	PART DESCRIPTION	AMPEX PART NO.
	SHIELD, tube, for all except V7	160-012
	SHIELD, tube: V7	160-043
	SHOCKMOUNT	350-015
	SOCKET, tube: 7 pin	150-067
	SOCKET, tube: 9 pin	30818-01
	EQUALIZER BRACKET ASSEMBLY (COMPLETE)	30920-01

ACCESSORIES

	KNOB ASSEMBLY: editing	1917-00
	KNOB ASSEMBLY: holddown (for 1/4-inch and 1/2-inch machines)	5053-00
	KNOB ASSEMBLY: holddown (for 1-inch machines)	5881-00
	REEL ADAPTOR	973-00
	CABLE ASSEMBLY, power interconnecting (300-2)	30841-01
	CABLE ASSEMBLY, bias (300-3)	14943-04
	CABLE ASSEMBLY, bias (300-4)	14943-03
	CABLE ASSEMBLY, bias (300-2)	14943-02
	CABLE ASSEMBLY, power interconnecting (300-3)	30851-01
	CORD SET	084-005
	ADAPTOR TEE: coax	169-012
	PANEL, backing (7 inch)	6962-00
	PANEL, facing (7 inch)	6963-00
	PANEL, backing	30828-01
	PANEL, facing	30829-01
	CONNECTOR, plug: female, 3 contact; Cannon Part No. XL-3-11	144-003
	CONNECTOR, plug: male, 3 contact; Cannon Part No. XL-3-12	145-009
	SPACER, base plate head assembly	5888-00

*Etched board assemblies are complete with all mounted components including tubes.

When ordering replacement parts always include the following information: Equipment Type; Equipment Serial Number; Ampex Part or Catalog Number; and Description of Part. DO NOT simply use the schematic reference number.

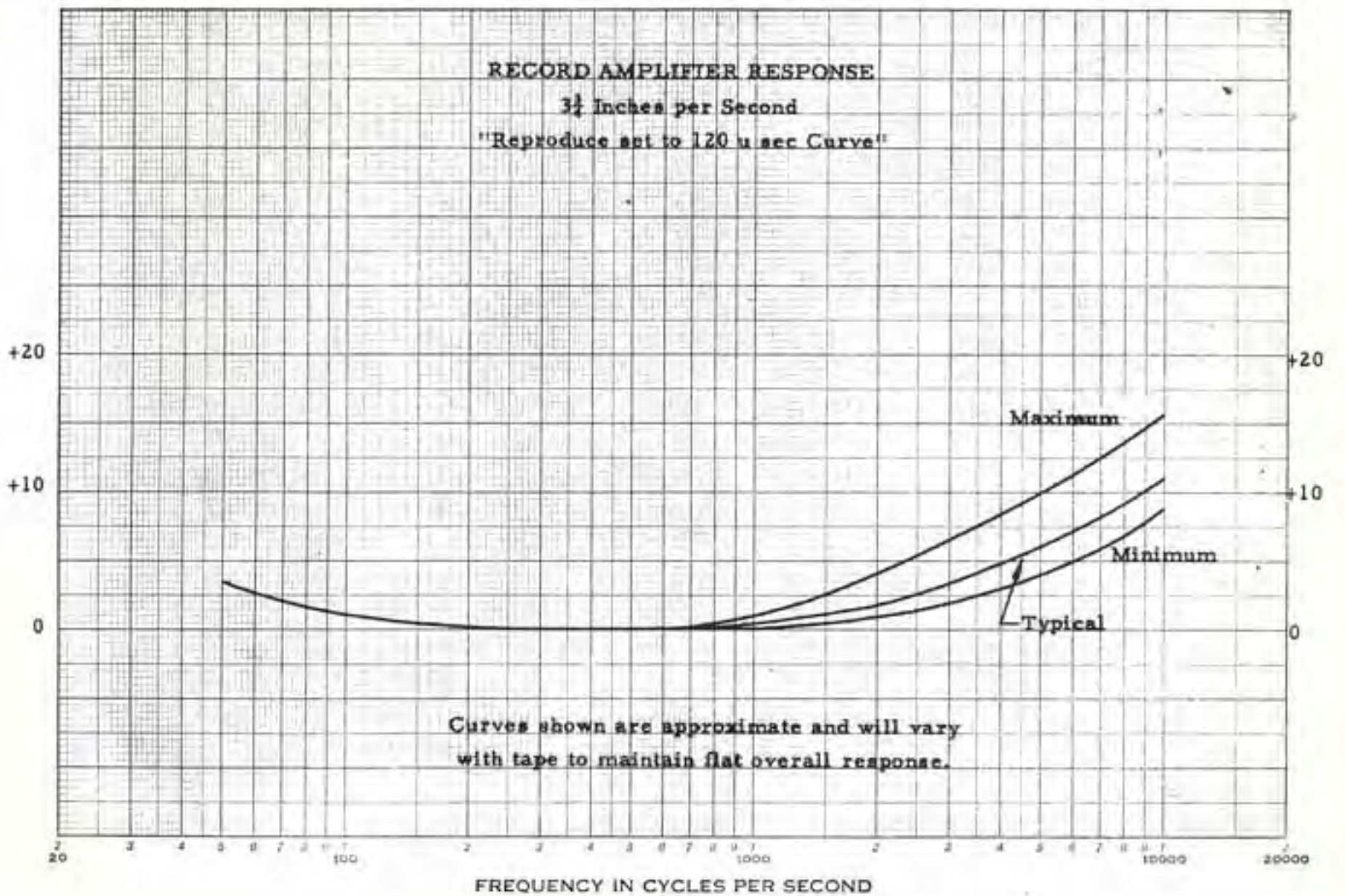
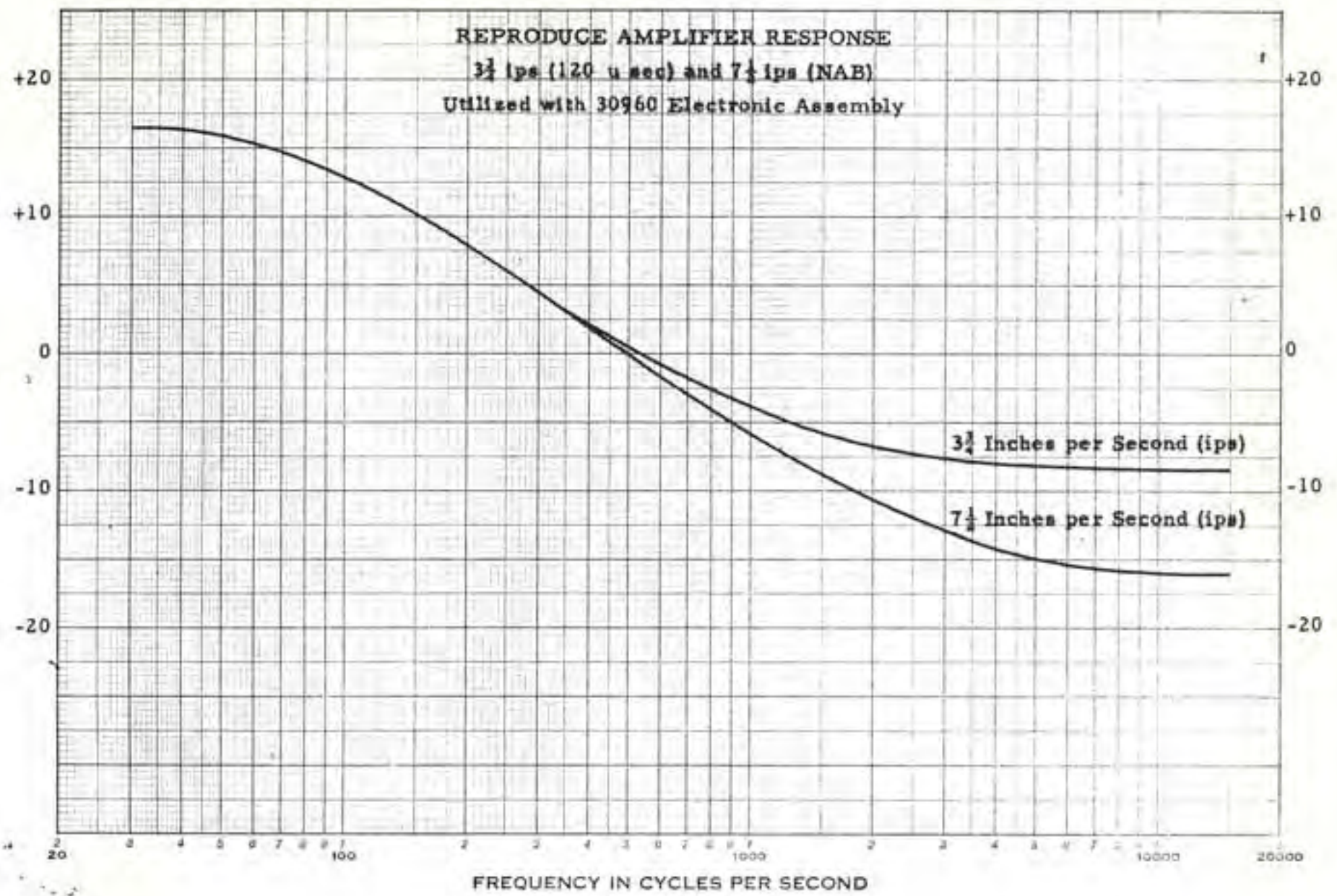

RECORD AMPLIFIER RESPONSE
7 1/2 Inches per Second (NAB)
 Utilized with 30960 Electronic Assembly

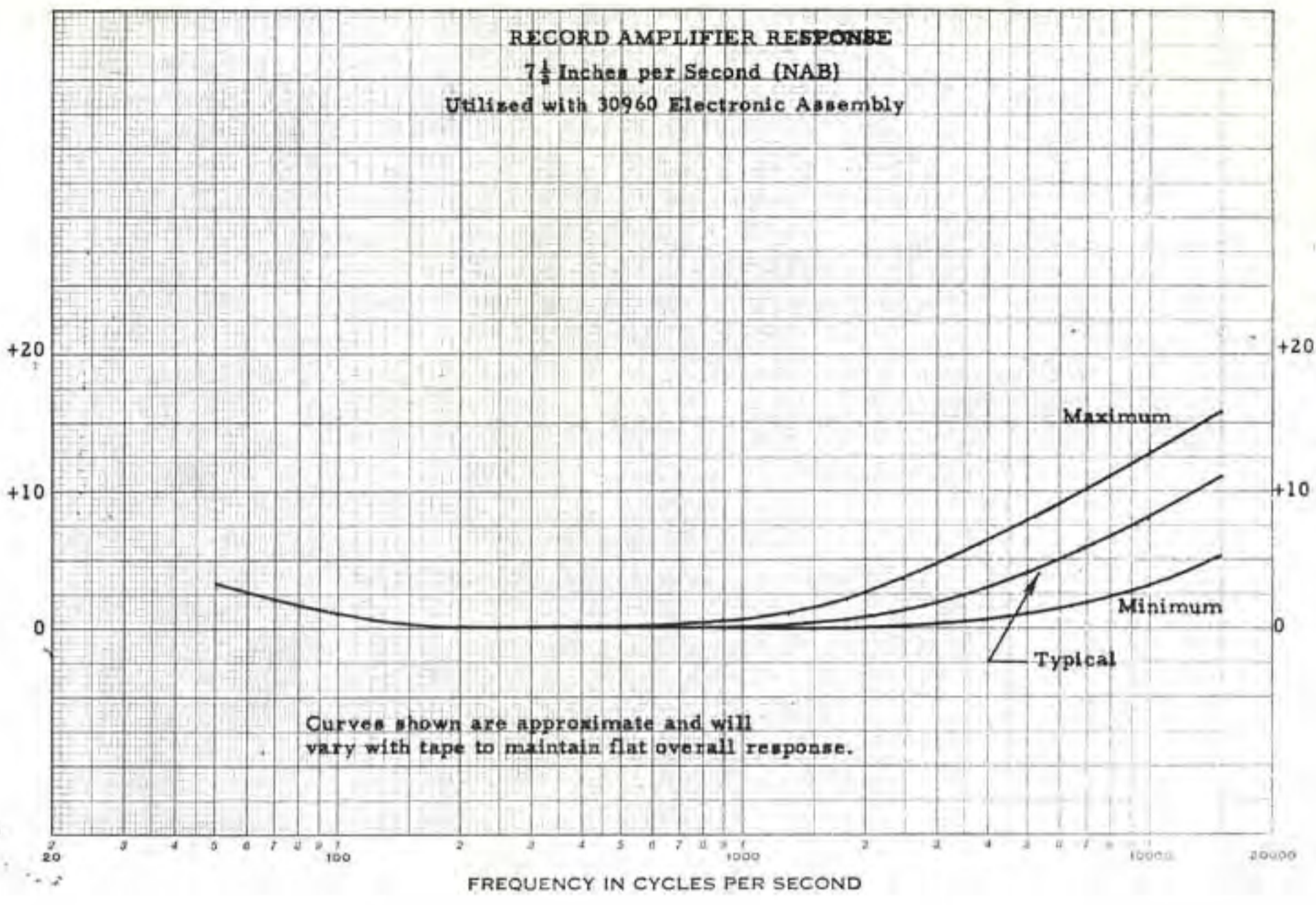

RECORD AMPLIFIER RESPONSE
15 Inches per Second (NAB)
 Utilized with 30960 Electronic Assembly

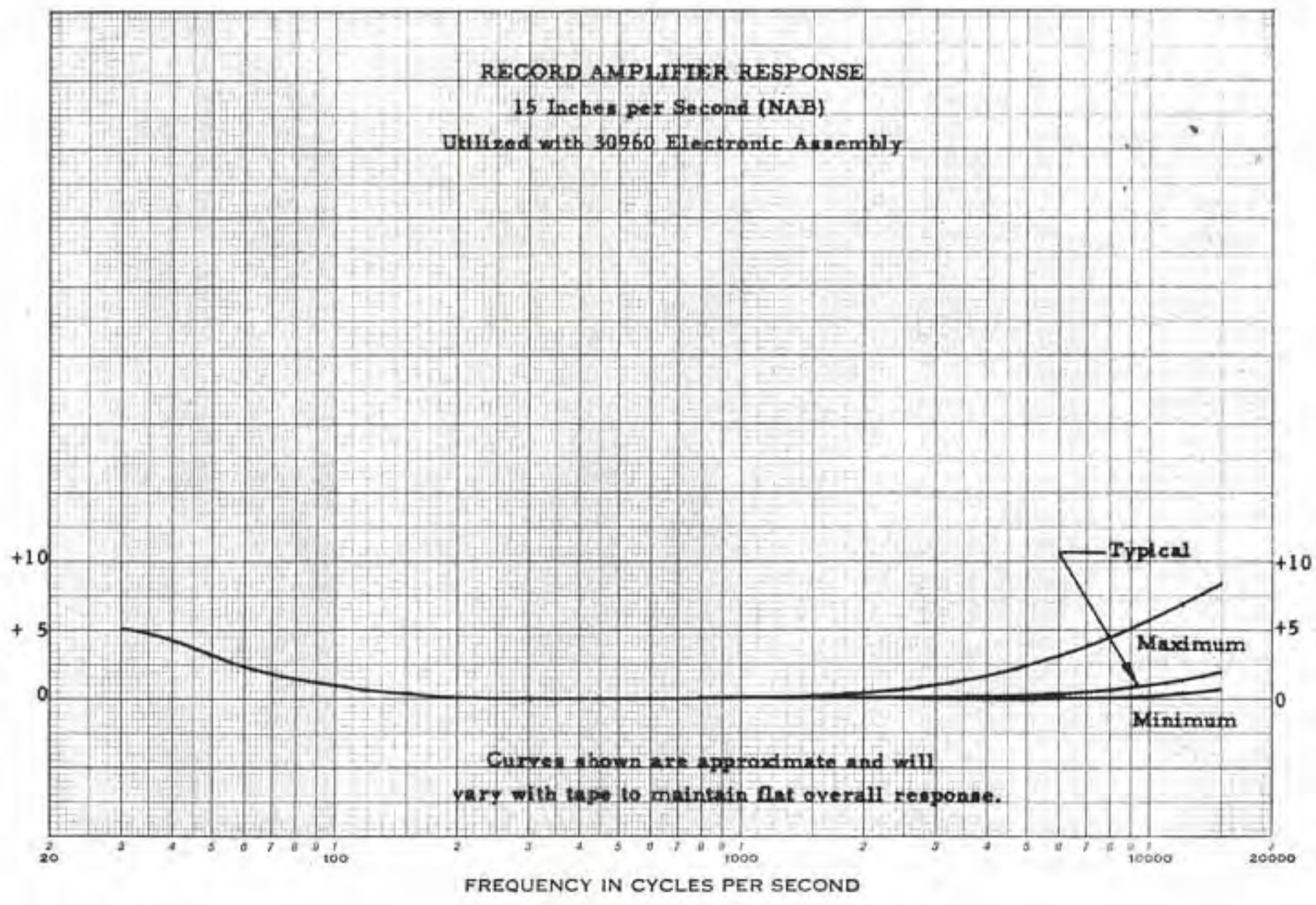

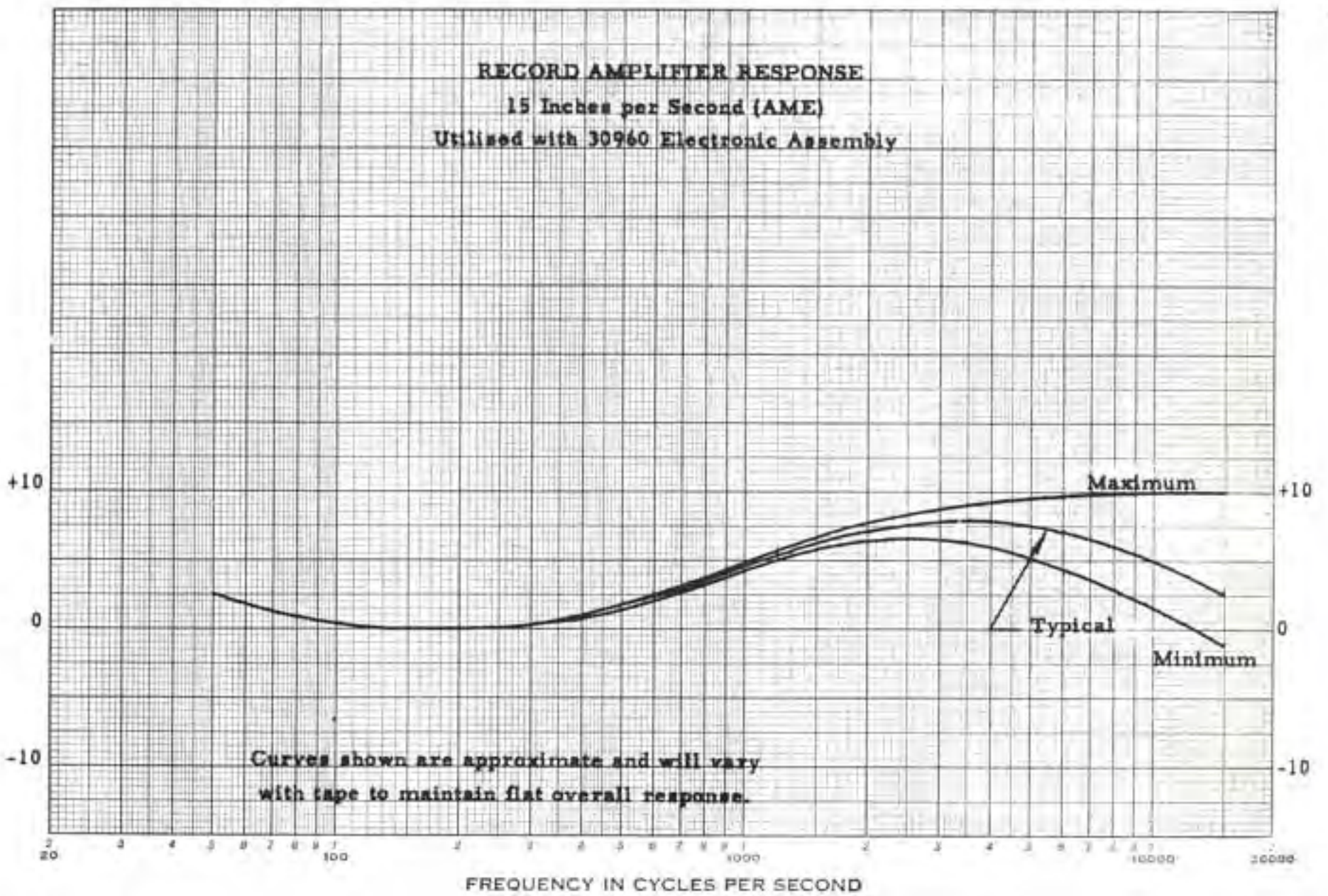
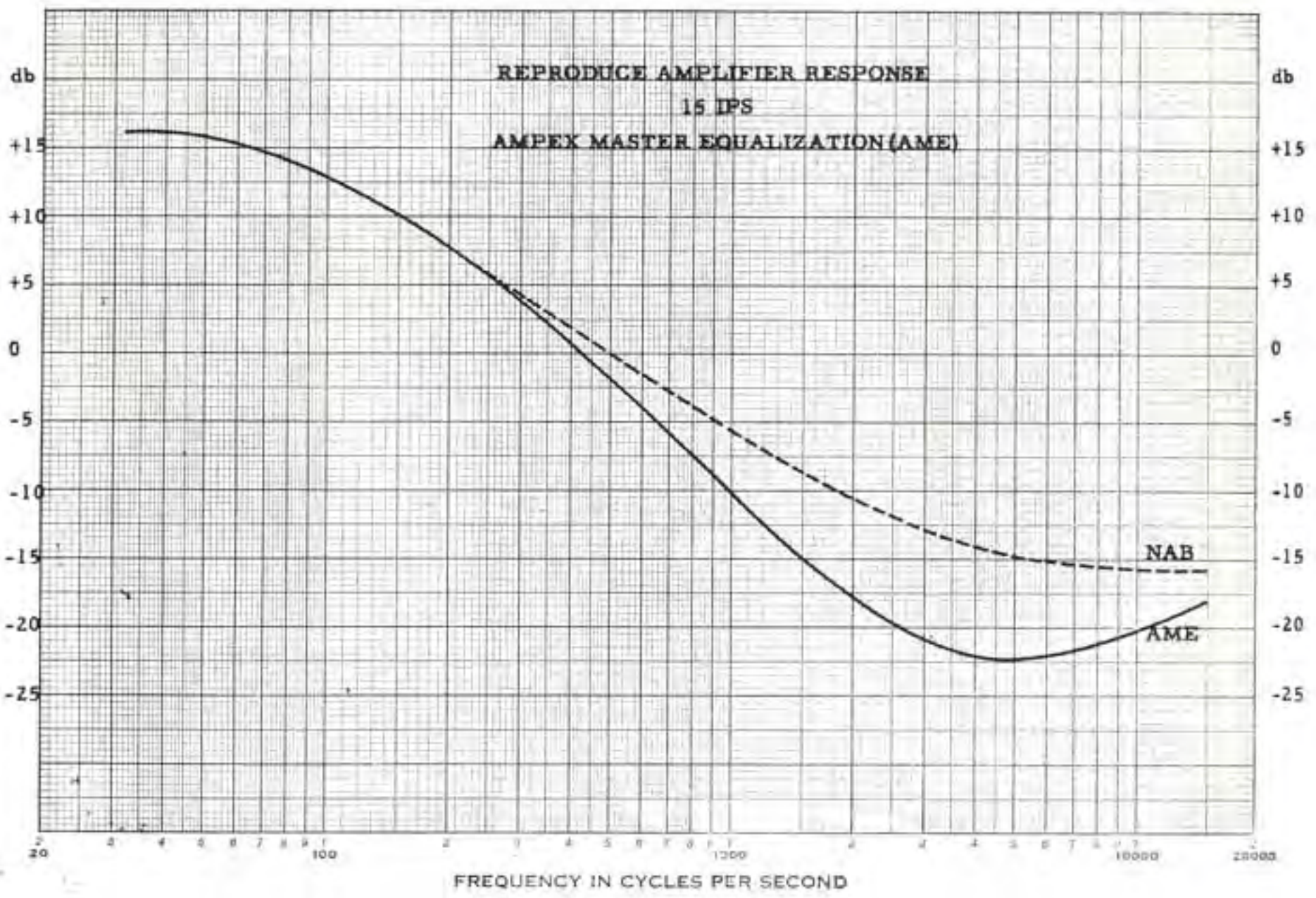

REPRODUCE RESPONSE OF STANDARD
TAPE NO. 31311-01
AMPEX MASTER EQUALIZATION (AME)
REPRODUCE CURVE

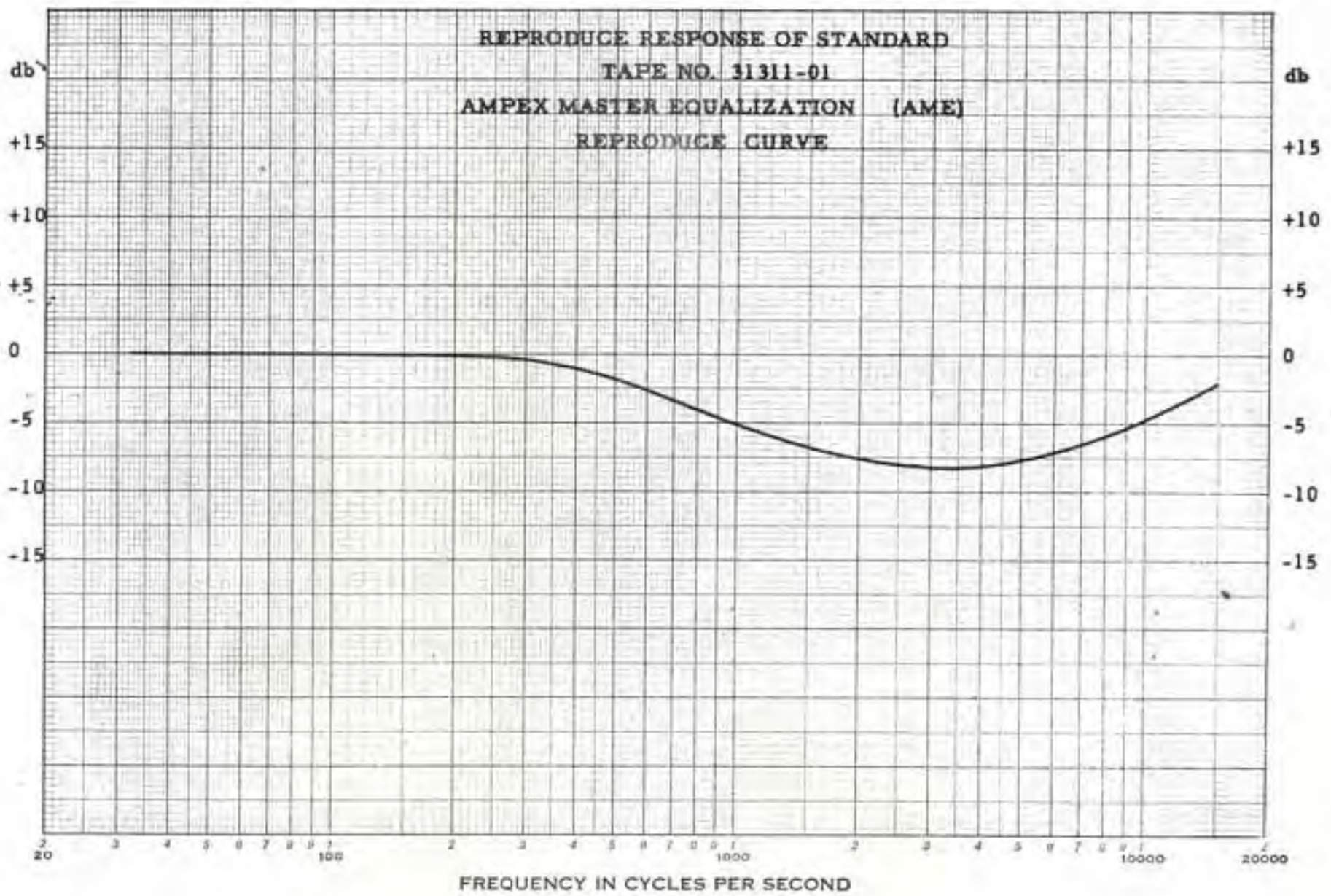

UTILIZED WITH 30960 ELECTRONIC ASSEMBLIES ONLY

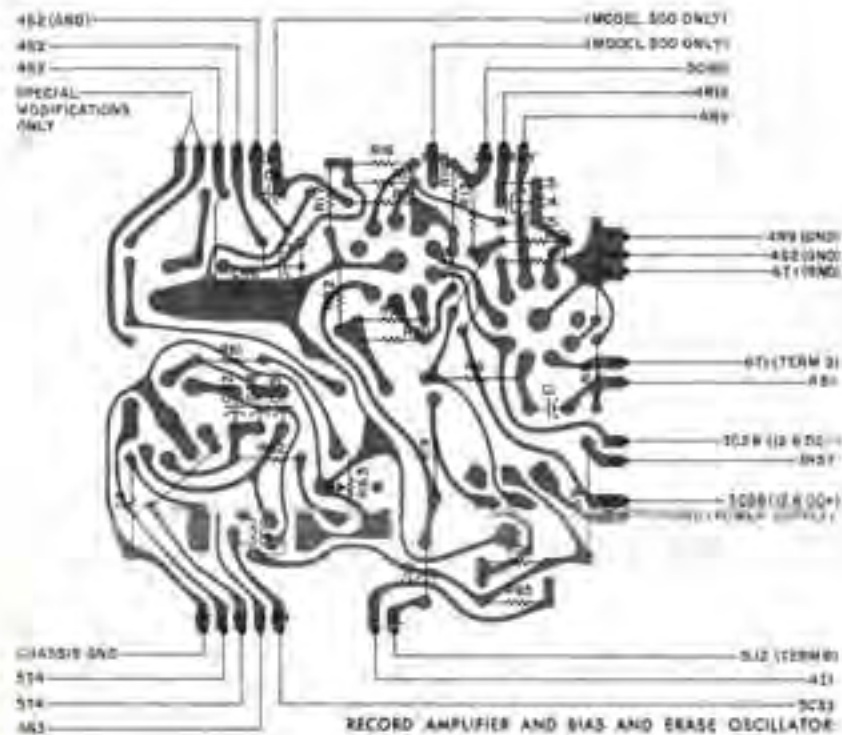

PARTS LOCATION

RECORD AMPLIFIER AND BIAS AND ERASE OSCILLATOR

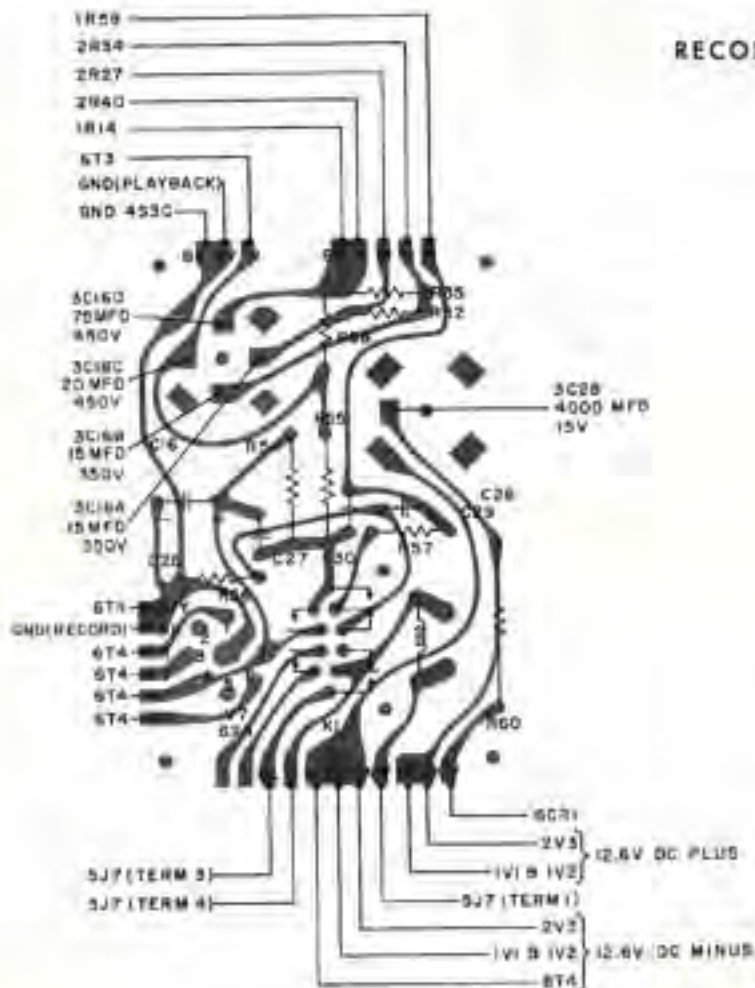

PARTS LOCATION

POWER SUPPLY AND REPRODUCE AMPLIFIER

UTILIZED WITH 30960 ELECTRONIC ASSEMBLIES ASSEMBLIES ONLY

LEGEND

THE FIRST NUMBERS SIGNIFY THE LOCATION.

1. RECORD AMPLIFIER BOARD
2. REPRODUCE AMPLIFIER BOARD
3. POWER SUPPLY BOARD
4. FRONT PANEL OF AMP CHASSIS
5. BACK PANEL OF AMP CHASSIS
6. SIDES AND BOTTOM

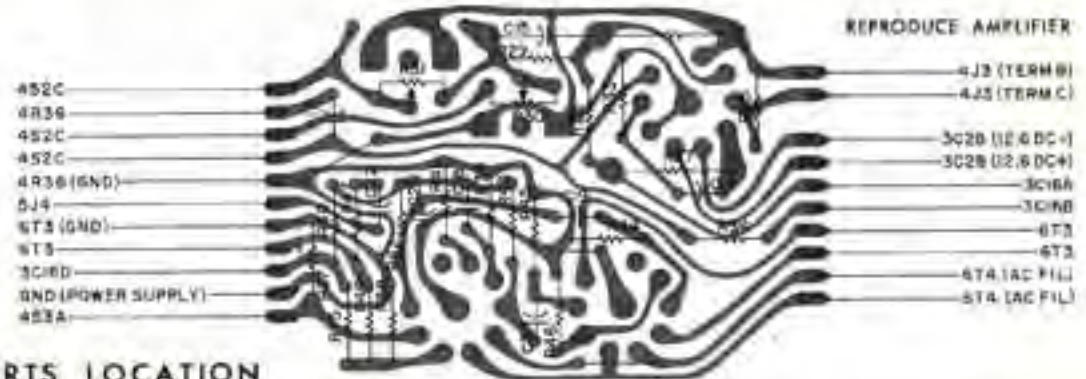

ELECTRONIC ASSEMBLY
2,3 and 4 TRACK RECORDER/REPRODUCER
7 1/2-15-15AME IPS SCHEMATIC DIAGRAM

30750-09 thru -10
30802L 2 of 2

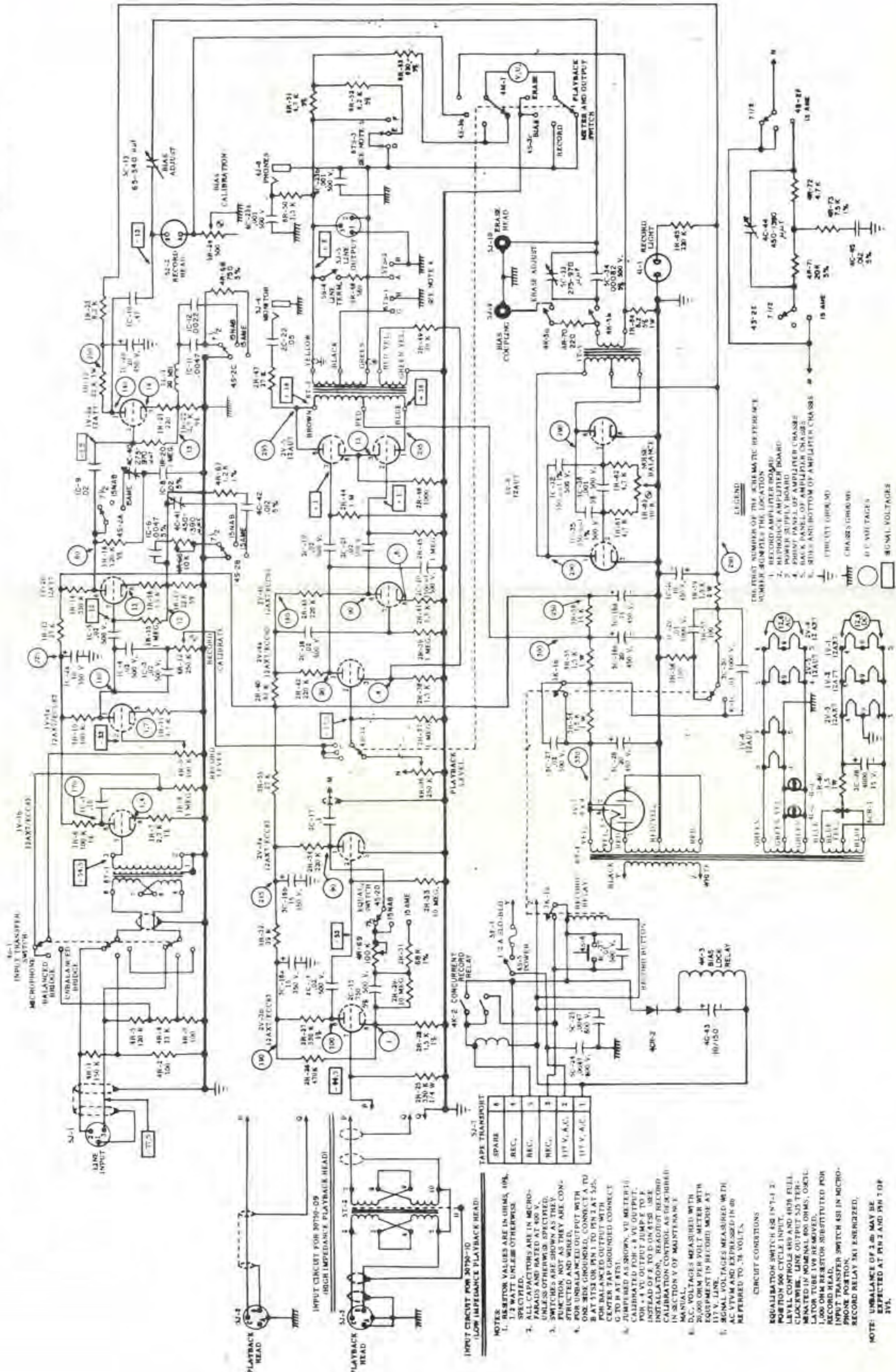

- NOTES:**
1. RESISTOR VALUES ARE IN OHMS, OHM, K, OR M, UNLESS OTHERWISE SPECIFIED.
 2. ALL CAPACITORS ARE IN MICROFARADS AND RATED AT 50V, UNLESS OTHERWISE SPECIFIED.
 3. SWITCHES ARE SHOWN AS THEY ARE CONSTRUCTED, NOT AS THEY ARE CONNECTED AND WIRED.
 4. FOR UNBALANCED OUTPUT WITH ONE SIDE GROUNDING, CONNECT A TO B AT 3T5 OR PIN 1 TO PIN 2 AT 5T5. FOR BALANCED OUTPUT WITH CENTER TAP GROUNDING, CONNECT G TO H AT 8T5.
 5. JUMPERS AS SHOWN, VU METER (1) CALIBRATED FOR +8 VU OUTPUT. FOR +4 VU OUTPUT JUMPER TO F INSTEAD OF E TO D ON 8T5. USE INSTALLATION, RECALIBRATE RECORD CALIBRATION CONTROL AS DESCRIBED IN SECTION V OF MAINTENANCE MANUAL.
 6. D.C. VOLTAGES MEASURED WITH 20,000 OHM PER VOLT METER WITH EQUIPMENT IN RECORD MODE AT 110 V. LINE.
 7. SIGNAL VOLTAGES MEASURED WITH 1,000 OHM RESISTOR SUBSTITUTED FOR RECORD HEAD.
 8. INPUT TRANSFER SWITCH 4S1 IN MICROPHONE POSITION.
 9. RECORD RELAY 3K1 ENERGIZED.
- NOTE:** UNBALANCE OF 1.00 MAY BE EXPECTED AT PIN 2 AND PIN 7 OF 3V5.
- CIRCUIT CONDITIONS**
- EQUALIZATION SWITCH 4S1 IN 7-1 2 POSITION 500 CYCLE INPUT.
CLOCKWISE, LINE OUTPUT 525 TERMINATED IN NOMINAL 600 OHMS, OSCILLATOR TUBE 1V8 RE-MOVED.
RECORD HEAD.
INPUT TRANSFER SWITCH 4S1 IN MICROPHONE POSITION.
RECORD RELAY 3K1 ENERGIZED.
- LEGEND**
- THE FIRST NUMBER OF THE SCHEMATIC REFERENCE NUMBER INDICATES THE LOCATION:
1. RECORD AMPLIFIER BOARD
 2. MICROPHONO BOARD
 3. POWER SUPPLY BOARD
 4. FRONT PANEL OF AMPLIFIER CHASSIS
 5. BACK PANEL OF AMPLIFIER CHASSIS
 6. SIDE AND BOTTOM OF AMPLIFIER CHASSIS
 7. TUBE SOCKET
 8. CHASSIS GROUND
 9. D.C. VOLTAGE
 0. SIGNAL VOLTAGE

ELECTRONIC ASSEMBLY

2,3 and 4 TRACK RECORDER/REPRODUCER
7-1/2-15.15AME IPS SCHEMATIC DIAGRAM

30960-05 thru -06

30961E 2 of 2

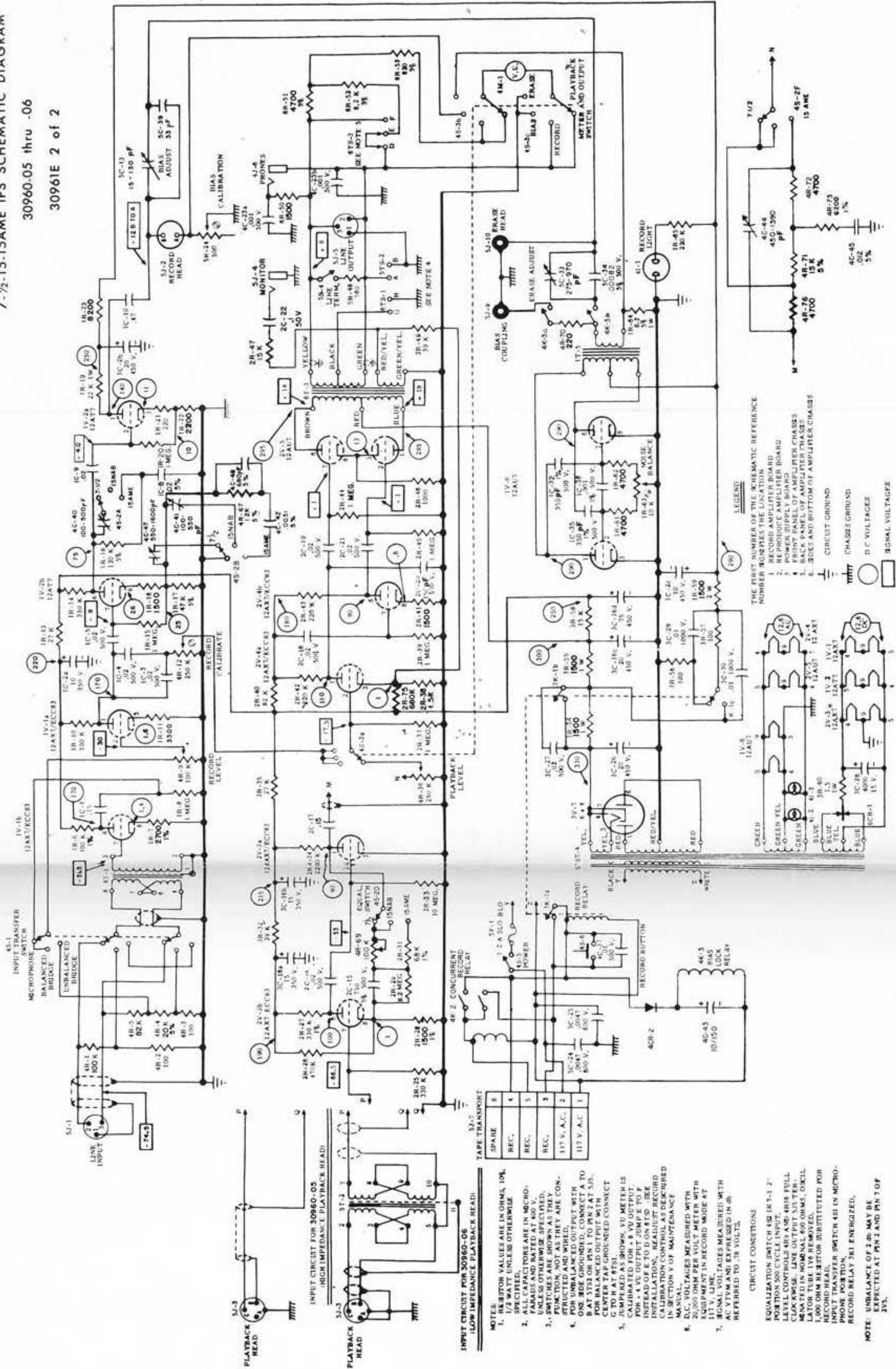

NOTE: UNBALANCE OF 2 DB MAY BE EXPECTED AT PIN 1 AND PIN 7 OF 3V5.

SCHEMATIC DIAGRAM
3 CHANNEL SEL-SYNC

30691B

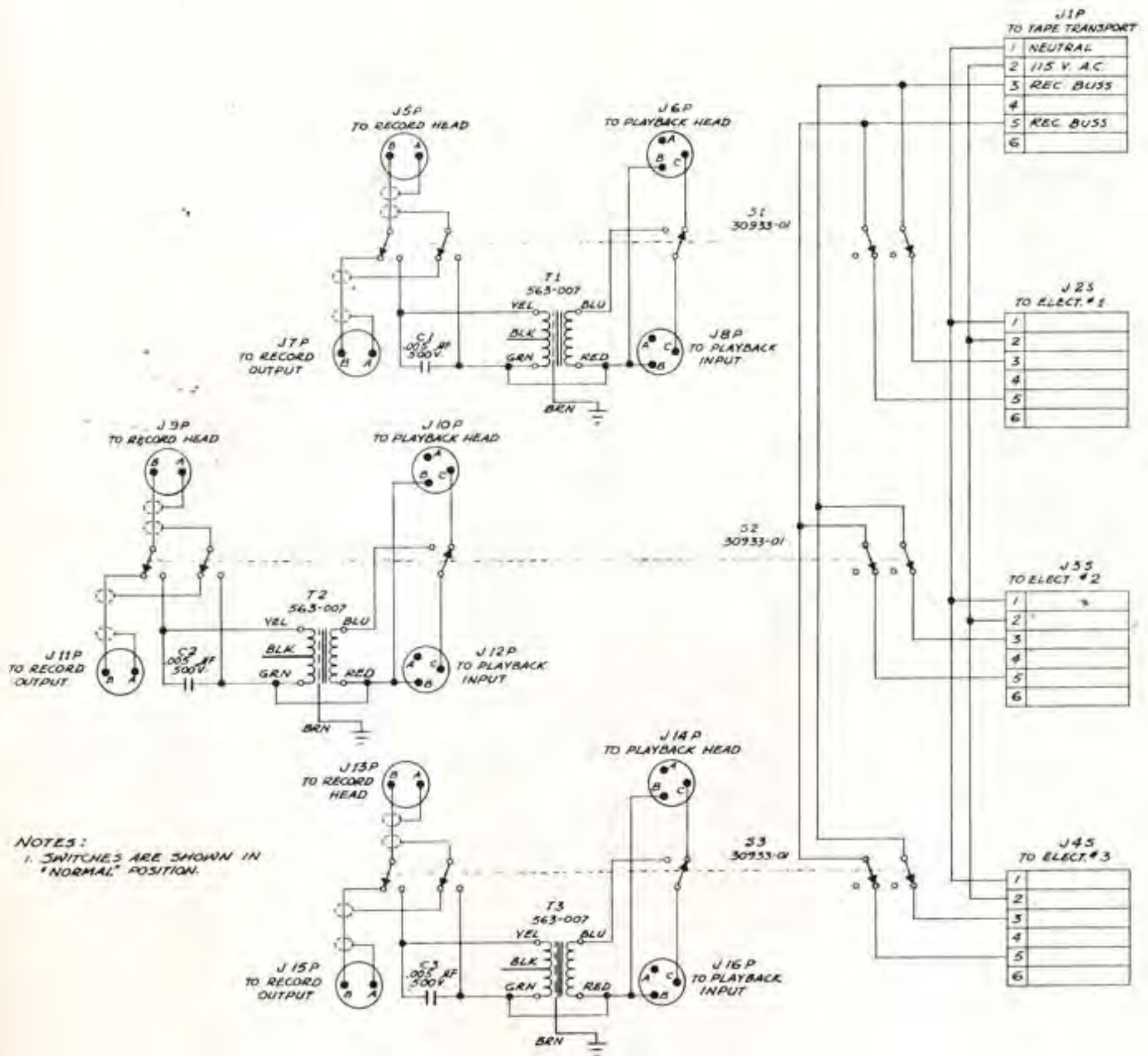

NOTES:
1. SWITCHES ARE SHOWN IN "NORMAL" POSITION.

Ampey 700 Series



934 CHARTER STREET REDWOOD CITY CALIFORNIA